

Science with Passion



Azura

Pump P 6.1L Instructions



Document no. V6890

HPLC



Note: For your own safety, read the instructions and follow the warnings and safety information on the device and in the instructions. Keep the instructions for future reference.



Note: In case you require this instruction in another language, please submit your request including the corresponding document number via e-mail or fax to KNAUER.

Support: Do you have questions about the installation or the operation of your instrument or software?

International Support:

Contact your local KNAUER partner for support:

www.knauer.net/en/Support/Distributors-worldwide

Support in Germany

(Austria & Switzerland on case-to-case basis):

Phone: +49 30 809727-111 (workdays 9-17h CET)

Fax : +49 30 8015010

E-mail: support@knauer.net

Publisher: KNAUER Wissenschaftliche Geräte GmbH

Hegauer Weg 38

14163 Berlin

Germany

Phone: +49 30 809727-0

Internet: www.knauer.net

Fax: +49 30 8015010

E-mail: info@knauer.net

Version information: Document number: V6890

Version number: 4.11

Release date: November 14, 2022

Translation of the original edition

These instructions apply to products with the product number: EPHXXYYZZ, EPH31 and EPH60XXEX

The information in this document is subject to change without prior notice. For the latest version of the instructions, visit our website: www.knauer.net/library.



Copyright: This document contains confidential information and may not be reproduced without written consent of KNAUER Wissenschaftliche Geräte GmbH.

© KNAUER Wissenschaftliche Geräte GmbH 2022
All rights reserved.

AZURA® is a registered trademark of
KNAUER Wissenschaftliche Geräte GmbH.

Table of contents

1. General	1
1.1 About these instructions	1
1.2 Signal words	1
1.3 Additional typographical conventions	1
1.4 Legal information	2
1.4.1 Liability limitation	2
1.4.2 Transport damage	2
1.4.3 Warranty conditions	2
1.4.4 Warranty seal	2
1.4.5 Declaration of conformity	2
2. Basic safety instructions	3
2.1 Intended use	3
2.1.1 Operating ranges	3
2.1.2 Foreseeable misuse	3
2.2 User qualification	3
2.3 Operator responsibility	4
2.4 Personal safety equipment	4
2.5 Safety features on the device	4
2.6 Working with solvents	5
2.6.1 General requirements	5
2.6.2 Contamination by health-threatening solvents	5
2.6.3 Avoiding leakage	5
2.7 Specific environments	6
2.7.1 Earthquake-endangered areas	6
2.7.2 Explosive environment	6
2.7.3 Cooling room	6
2.7.4 Wet room	6
2.8 Maintenance, care and repair	6
2.9 Service request form and decontamination report	7
3. Product information	8
3.1 Features	8
3.2 Performance features	8
3.3 Device variants	9
3.4 Scope of delivery	9

3.5	Views	10
3.5.1	Front view	10
3.5.2	Rear view	11
3.6	Meaning of the LEDs	12
3.7	Symbols and signs	13
4.	Installation and initial startup	15
4.1	Unpacking	15
4.2	Ambient conditions	15
4.2.1	Operation site	15
4.2.2	Ambient temperature	15
4.2.3	Space requirements	16
4.3	Power supply	16
4.4	Connecting capillaries and fittings	17
4.4.1	Connecting the solvent bottles	17
4.4.2	Pre-installed capillaries	17
4.4.3	Integrating the pump into a HPLC system	18
4.5	Isocratic pump	18
4.5.1	Connecting the pump head to the solvent	19
4.6	Binary pump	20
4.6.1	Connecting the degasser (depending on version)	21
4.6.2	Connecting the pump head to the solvent	21
4.6.3	Connecting the solvent selection valve to the solvent (depending on version)	21
4.7	Quaternary pump	22
4.7.1	Connecting the degasser (depending on version)	22
4.7.2	Connecting the pump head to the solvent	22
4.7.3	Connecting the 4-channel degasser to the solvent	23
4.7.4	Connecting the valve block	23
4.8	Connecting the piston backflushing	23
4.9	Connecting the leak management	25
4.10	Control	26
4.10.1	Setting up LAN	26
4.10.2	Configuring LAN settings	27
4.10.3	Connecting devices with LAN	27
4.10.4	Configuring the router	28
4.10.5	Integrating LAN into the company network	28
4.10.6	Controlling several systems separately in LAN	29
4.11	Setting IP addresses via software	29
4.11.1	Mobile Control: Setting a static IP address	29
4.11.2	Mobile Control: Setting a dynamic IP address via device name	30

4.11.3	Mobile Control: Setting a dynamic IP address via device serial number	31
4.11.4	Firmware Wizard: Setting a static IP address.	32
4.11.5	Firmware Wizard: Setting a dynamic IP address.	33
4.12	Remote control.	34
4.12.1	Connector assignment	34
4.12.2	Connecting the pin header	37
4.13	Analog control	38
5.	Operation	39
5.1	Initial operation	39
5.1.1	Pump head running-in	39
5.2	Purging the pump	39
5.3	Switch-on.	41
5.4	Software control	41
5.4.1	Controlling with chromatography software.	41
5.4.2	Controlling with Mobile Control	41
6.	Functionality tests	42
6.1	Installation Qualification (IQ)	42
6.2	Operation Qualification (OQ)	42
7.	Troubleshooting.	43
7.1	LAN.	43
7.2	Possible problems and solutions.	44
7.3	System messages.	45
8.	Maintenance and care	50
8.1	Maintenance contract	50
8.2	Maintenance intervals.	50
8.3	Cleaning and caring for the device.	51
8.4	Checking the fittings	51
8.5	Flushing the pump.	51
8.6	Maintaining the pump head.	52
8.6.1	Dismounting the pump head	52
8.6.2	Check valves.	54
8.7	Inline filter on the pressure sensor	55
8.7.1	Removing the inline filter	56
8.7.2	Inserting the new inline filter cartridge	56
8.8	Replacing the mixer.	58
8.9	Removing a leakage	58

9. Transport and storage	59
9.1 Putting the pump out of operation	59
9.2 Packing the device	59
9.3 Transporting the device	59
9.4 Storing	59
9.4.1 Storing the device	59
9.4.2 Storing the pump head	60
10. Disposal	61
10.1 AVV-Marking Germany	61
10.2 WEEE registration number	61
10.3 Eluents and other operating materials	61
11. Technical data	62
11.1 Main features	62
11.2 Communication	63
11.3 General	63
11.4 Device variants	64
11.4.1 Isocratic	64
11.4.2 Binary	64
11.4.3 Quaternary	65
11.5 Pump heads	66
12. Chemical compatibility of wetted materials	67
12.1 General	67
12.2 Plastics	67
12.3 Non-metals	69
12.4 Metals	70
13. Repeat orders	71
13.1 Devices	71
13.2 Accessories and spare parts	72

1. General

1.1 About these instructions

These operating instructions enable the safe and efficient operation of the device. The user must have carefully read and understood these operating instructions before starting any work.





The basic prerequisite for safe operation is compliance with all safety instructions (see „2 Basic safety instructions“, p. 3). In addition to the safety and warning instructions in these operating instructions, the local accident prevention regulations and the national industrial safety regulations apply.

These operating instructions are an integral part of the device. It must be kept in the immediate vicinity of the device and accessible to the user at all times.

You can download these and other instructions from the KNAUER website: www.knauer.net/library

1.2 Signal words

Possible dangers related to the device are distinguished in personal and material damages.

Symbol	Meaning
	DANGER (red) indicates a highly hazardous situation. If not avoided, it will result in death or serious injury.
	WARNING (orange) indicates a hazardous situation. If not avoided, it could result in death or serious injury.
	CAUTION (yellow) indicates a moderate hazardous situation. If not avoided, it could result in minor or moderate injury.
	NOTICE (blue) is used to address issues which are not related to physical injury.

1.3 Additional typographical conventions

Note: Specific information are prefixed with the word „Note“ and an information icon.

 **Note:** This is an example.

1.4 Legal information

1.4.1 Liability limitation

The manufacturer is not liable for the following issues:

- Non-compliance of these instructions
- Non-observance of necessary safety precautions
- Improper use
- Operation of the device by unqualified personnel (see „2.2 User qualification“, p. 3)
- Use of non-approved spare parts
- Technical changes by the user such as opening the device and unauthorized modifications
- Violations of General Terms and Conditions (GTC)

1.4.2 Transport damage

The packaging of our devices provides the best possible protection against transport damage. However, check the packaging for transport damage. In case you notice any damage, inform the Technical Support and the shipping company within three workdays.

1.4.3 Warranty conditions

For information on warranty please refer to our general terms and conditions on the website: www.knauer.net/terms

1.4.4 Warranty seal

A blue or orange warranty seal is affixed to some devices.

- A blue seal is used by KNAUER's Manufacturing or Customer Support for devices to be sold.
- After repair, service technicians attach an orange seal onto the identical position.

After repair, the service technician affixes an orange seal in the same place. If unauthorised persons tamper with the device or if the seal is damaged, the warranty will lapse.



1.4.5 Declaration of conformity

The declaration of conformity is enclosed as a separate document with the product and can be obtained online:

www.knauer.net/en/Support/Declarations-of-conformity

2. Basic safety instructions

The device has been developed and constructed in such a way that hazards arising from its intended use are largely excluded. Nevertheless, the following safety instructions must be observed in order to exclude residual hazards.

2.1 Intended use

Only use the device for applications that fall within the range of the intended use. Otherwise, the protective and safety equipment of the device could fail.

2.1.1 Operating ranges

The device is intended to be used indoors for chromatographic applications.

2.1.2 Foreseeable misuse

Refrain from the use of the device for the following purposes or conditions:

- Medical purposes. The device is not approved as a medical product.
- Operating outdoors. Otherwise, the manufacturer does not guarantee the functionality and safety of the device.
- Operation in potentially explosive areas without special and additional explosion protection. Contact the KNAUER Customer Support for more information.

2.2 User qualification

The users are qualified to handle the device if all of the following points apply:

- They have at least a basic knowledge of liquid chromatography.
- They have knowledge about the properties of the used solvents and their health risks.
- They are trained for the special tasks and activities in the laboratory and know the relevant standards and regulations.
- Due to their technical training and experience, they can understand and carry out all the work described in the operating instructions on the instrument and recognize and avoid possible dangers independently.
- Their ability to react is not impaired by the consumption of drugs, alcohol or medication.
- They have participated in the installation of an instrument or training by KNAUER or an authorized company.

If users do not meet these qualifications, they must inform their supervisors.

2.3 Operator responsibility

The operator is any person who operates the device himself or leaves it to a third party for use and who bears the legal product responsibility for the protection of the user or third parties during operation.

The obligations of the operator are listed below:

- Know and follow the applicable work safety regulations.
- Identify hazards arising from the working conditions at the place of use in a risk assessment.
- Set up operating instructions for the operation of the device.
- Regularly check whether the operating instructions correspond to the current status of the regulations.
- Clearly regulate and specify responsibilities for installation, operation, troubleshooting, maintenance and cleaning and set clear rules.
- Ensure that all personnel who work with the device have read and understood these operating instructions.
- Train the personnel who work with the device at regular intervals and inform them about the dangers.
- Provide the necessary safety equipment to the employees working with the unit (see section below).

2.4 Personal safety equipment

The protective measures required in the laboratory must be observed and the following protective clothing worn during all work on the device:

- Safety glasses with side protection
- Protective gloves in accordance with the prevailing ambient conditions and used solvents (e.g. heat, cold, protection against chemicals)
- Lab coat
- Personalised protective safety equipment which is specified in the particular laboratory.

2.5 Safety features on the device

- Power switch: Devices of the AZURA® L series may be switched off using the power switch (toggle switch on the back side of housing) at any time, this causes no damage to the device. To switch off devices of the AZURA® S series, remove the plug from the power socket or use the toggle switch of the power supply unit.
- Front cover: Devices of the AZURA® L series have a front cover as a splash protection for the user
- Leak tray: Devices of the AZURA® L series have a leak tray on the front side. The leak tray collects leaking solvents and protects components from potential damage caused by discharging liquid.

2.6 Working with solvents

2.6.1 General requirements

- The user is trained for handling different solvents.
- Note recommended solvents and concentrations in these instructions in order to avoid personal injury or damage to the device. For example, certain chemicals may cause PEEK capillaries to swell or burst (see „12 Chemical compatibility of wetted materials“, p. 67).
- Note that organic solvents are toxic above a certain concentration. For handling hazardous solvents see the following section.
- Mobile phases and samples may contain volatile or combustible solvents. Avoid the accumulation of these substances. Ensure good ventilation of the installation site. Avoid open flames and sparks. Do not operate the instrument in the presence of flammable gases or vapors.
- Only use solvents which do not self-ignite under given conditions. This applies especially to the use of a thermostat where liquids could get onto hot surfaces in the interior.
- Degas solvents before use and observe their purity.

2.6.2 Contamination by health-threatening solvents

- Contamination with toxic, infectious or radioactive substances poses a hazard for all persons involved during operation, repair, sale, and disposal of a device.
- All contaminated devices must be properly decontaminated by a specialist company or the operating company before they can be recommissioned, repaired, sold, or disposed (see „10 Disposal“, p. 61).

2.6.3 Avoiding leakage

Risk of electrical shock or short circuit if solvents or other liquids leak into the interior of the device. You can avoid a leakage through the following measures:

- Tightness: Visually check the device or system regularly for leaks.
- Solvent tray: The use of a solvent tray prevents liquids get from the bottles into the inside of the device.
- Eluent lines: Install capillaries and hoses in such a way that, in case of a leak, liquids cannot get into the interior of the devices underneath.
- In case of leakage: Switch off the system. Only take the device into operation if the cause of the leak has been resolved (see „8 Maintenance and care“, p. 50).

2.7 Specific environments

2.7.1 Earthquake-endangered areas

In earthquake-endangered areas, do not stack more than 3 devices on top of each other. Otherwise there is risk of injury due to falling devices or loose parts.

2.7.2 Explosive environment

Never use the system in potentially explosive atmospheres without appropriate protective equipment. For more information, contact the KNAUER Customer Support.

2.7.3 Cooling room

You may operate the device in a cooling room. To prevent condensation, note the following instructions:

- Allow the device to acclimatize for min. 3 hours before taking it into operation.
- After taking into operation, the device should stay switched on.
- Avoid temperature fluctuations.

2.7.4 Wet room

The device must not be operated in wet rooms.

2.8 Maintenance, care and repair

- Avoiding electric shock: Before performing any maintenance and service work, disconnect the device from the power supply.
- Tools: Use only tools recommended or prescribed by the manufacturer.
- Spare parts and accessories: Only use original parts and accessories made by KNAUER or a company authorized by KNAUER.
- PEEK fittings: Use PEEK fittings only for a single port or brand-new PEEK fittings in order to avoid dead volume or not exactly fitting connections.
- Column care: Follow KNAUER or other manufacturer's instructions on caring for the columns (see www.knauer.net/columncare).
- Used capillaries: Do not use any used capillaries elsewhere in the system in order to avoid dead volumes, not exactly fitting connections and spreading contamination.
- Safety features: The device may only be opened by the KNAUER Customer Support of KNAUER or any company authorized by KNAUER (see „1.4.1 Liability limitation“, p. 2).
- For more information visit the KNAUER website: www.knauer.net/hplc-troubleshooting.

2.9 Service request form and decontamination report

Devices which are shipped without the completed document "Service request form and decontamination report" will not be repaired. If you would like to return a device to KNAUER, make sure to enclose the completed document: www.knauer.net/servicerequest

3. Product information

3.1 Features

AZURA® L features The AZURA® Pump P 6.1L¹ is a member of the AZURA® L product line and shares a number of common features.

- Removable front cover, for optional pump and/or user protection.
- Instrument stability through a large base area and low center gravity.
- The leak tray at the front side collects leaking fluids and protects components from possible damage.
- LED pump status indication. Thus, the user sees directly if the pump operates correctly or if an error as occurred.
- Power connection and control connectors on rear of the pump.

Identification The pump name can be found on the front panel, above the serial number. A silver sticker on the rear side displays the manufacturer name and address, the product number and power supply specifications.

3.2 Performance features

The pump is used to transport liquids, either in an HPLC system or as a stand-alone device. Liquids are pumped either with constant flow or with constant pressure. The flow rate and pressure at which liquids can be pumped depend on the pump head.

Pump heads Pump heads for several areas of application are available for the pump:

Parameter	Standard	Bio-inert
Size	5 ml, 10 ml and 50 ml	10 ml and 50 ml
Material	Pump head with stainless steel inlays	Pump head with ceramic inlays
Operating range	<ul style="list-style-type: none"> ■ HPLC ■ Dosing applications with non-aggressive media 	<ul style="list-style-type: none"> ■ Purification/FPLC ■ Ion chromatography <p>Note: The bio-inert pumps are equipped with UHMW PE piston seals. Check the chemical resistance of these materials for the application before use.</p>

Every pump head is equipped with an RFID chip. It is used to monitor and save all important parameters and settings. The RFID technology offers the following advantages:

- Software automatically recognizes the parameters of the pump head.
- All service-relevant data of the pump head is stored.

¹ The AZURA® Pump P 6.1L will further on be referred to as „pump“.

Mixer The mixer is exchangeable and is available as a 50, 100, 200 or 250 µl version. The volume of the mixer is indicated on the right side of the mixer. The parameters necessary for the mixer are set via Mobile Control or via chromatography software.

Parameter	Stainless steel	Bio-Inert
Size	50 µl, 100 µl, 200 µl	250 µl
Pressure	1000 bar	400 bar

Piston backflushing The piston backflushing function automatically flushes the rear piston area of the pump head upon switch-on and in continuous mode.

- Upon switch-on: The rear piston area of the pump head is automatically flushed for 15 seconds.
- In continuous mode: The rear piston area of the pump head is flushed automatically every 15 minutes, for 15 seconds.

P_{Max} mode This mode protects the column from excessive fluctuations in pressure. If the maximum pressure is reached, the user can decide if the pump should be switched off or continue running with constant pressure. You find a detailed description on chromatography software in the corresponding instructions.

GLP data The Mobile Control and the different software products can be used to display or read GLP data. A detailed description on how to display or read out GLP data can be found in the respective instructions.

3.3 Device variants

The pump is available in three variants:

- Isocratic pump
- Binary pump (HPG pump)
- Quaternary pump (LPG pump)

All variants are available as a standard version made of stainless steel or as a bio-inert version with wetted materials made of ceramics with PEEK capillary, PEEK connectors, and PEEK venting screw.

3.4 Scope of delivery

The following items are included in the scope of delivery:

- Power supply unit with power cable
- Device AZURA® Pump P 6.1L
- Pump accessory kit
- AZURA® accessory kit

Valid documents:

- AZURA® Pump P 6.1L Instructions V6890
- Supplement [V6894: Running-in procedure for pump heads](#)
- Declaration of Conformity

3.5 Views

3.5.1 Front view

Isocratic pump

The isocratic pump is equipped with a pressure sensor with an integrated inline filter and a venting screw. Depending on version, a 2-channel degasser with a solvent selection valve is also integrated.

Legend

- ① Pressure sensor
- ② Pump head
- ③ Solvent selection valve
- ④ Degasser

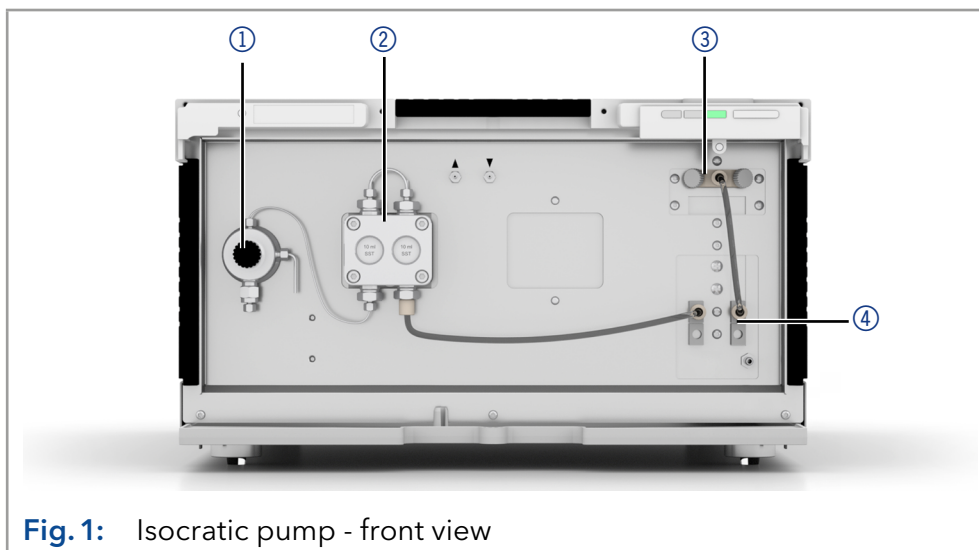

Fig. 1: Isocratic pump - front view

Binary pump

The binary pump consists of two pump drives and a 2-channel or 4-channel degasser with a solvent selection valve (depending on version). A pressure sensor with an integrated inline filter and a venting screw are also part of the pump as well as a mixer.

Legend

- ① Pressure sensor
- ② Mixer
- ③ Pump head
- ④ Solvent selection valve
- ⑤ Degasser

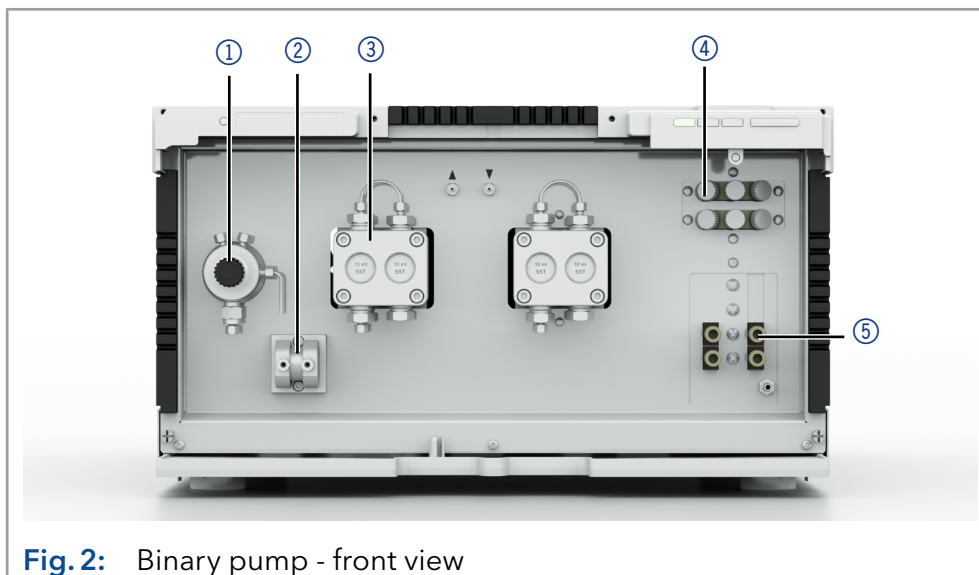

Fig. 2: Binary pump - front view

Quaternary pump The quaternary pump consists of a pump, a valve block and a 4-channel-degasser (depending on version). A pressure sensor with an integrated inline filter, a venting screw and a mixer are also part of the pump.



Note: The bio-inert quaternary pump is equipped with a valve block containing valve tappets made of FKM and a housing made of PPS. Check the chemical resistance of these materials for the application before use.

Legend

- ① Pressure sensor
- ② Mixing chamber
- ③ Pump head
- ④ Valve block
- ⑤ Degasser (optional)

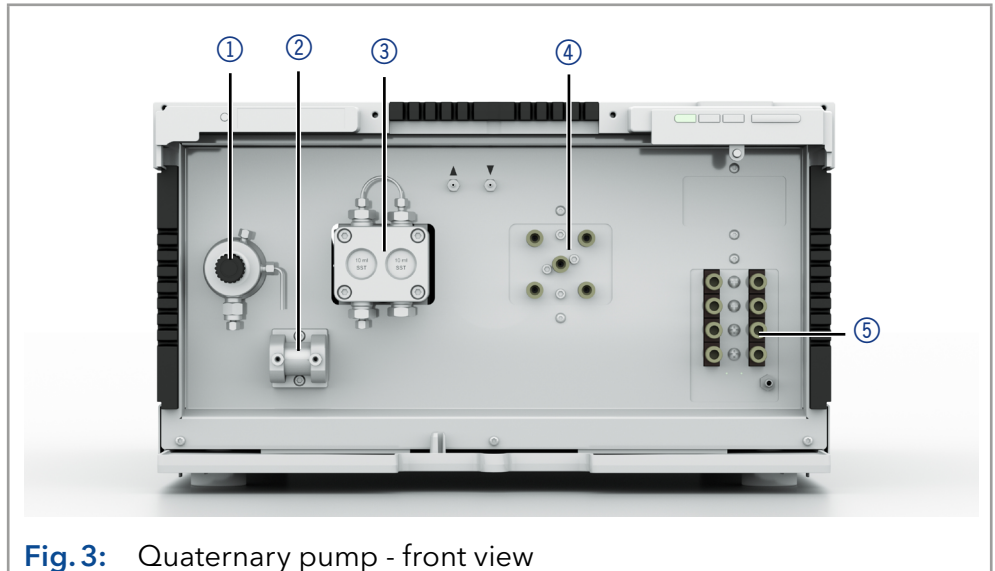

Fig. 3: Quaternary pump - front view

3.5.2 Rear view

On the back of the pump, the connectors for LAN and power chord are located as well as the serial number of the device and the power switch (on/off).

Service Interface Please note that the service interface is solely used for repair and maintenance tasks performed by service technicians.

Legend

- ① Serial number and symbols (see „3.7 Symbols and signs“, p. 13)
- ② Service board drive B (HPG version only, used exclusively for direct control of drive B via KNAUER Service Tool)
- ③ Pin header
- ④ LAN connector
- ⑤ Power connection and power switch

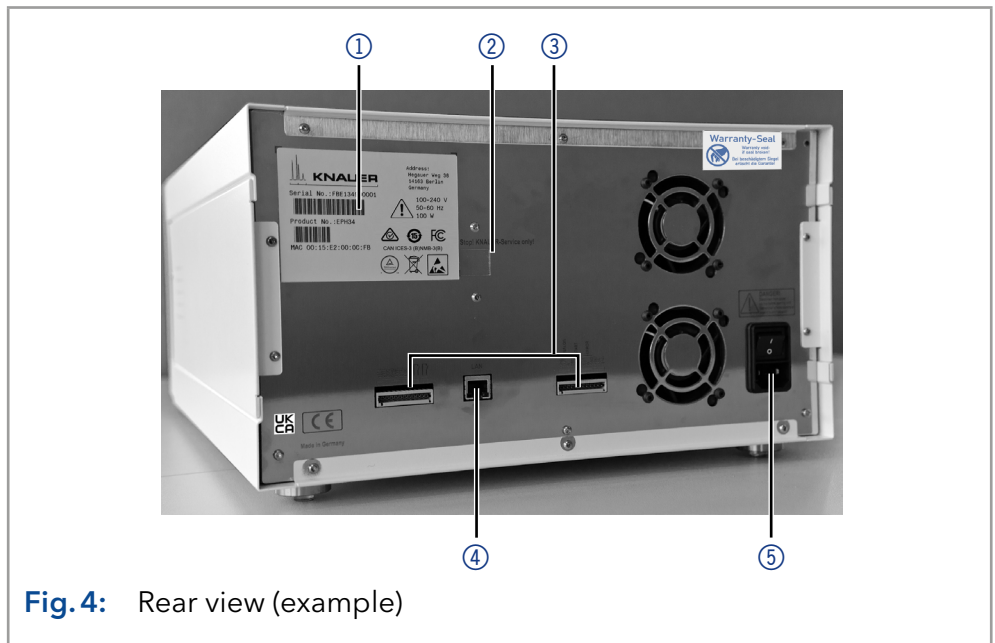
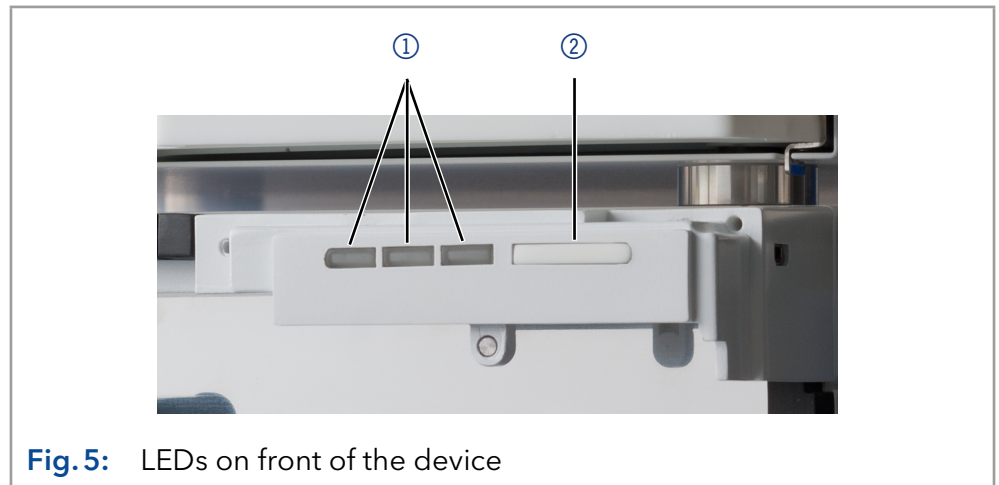

Fig. 4: Rear view (example)

3.6 Meaning of the LEDs

There are three LEDs ① and a standby switch ② on the front of the device. The figure shows the LED panel when the device is switched off.



The LEDs show different colors depending on the operating status.

	Color	Operating status	Measures
Left LED	Flashes red	Error message	<ul style="list-style-type: none"> Check the system. Shortly press the switch to deactivate the error message.
	Red	Serious error	<ul style="list-style-type: none"> Restart the device. If the operating condition does not change, contact Technical Support.
	Green	Program or sequence is running / has been loaded.	-
Center LED	Off	Not ready for operation	-
	Green	Ready for operation	-
Right LED	Green	Switched on	-
	Blue	Standby	<ul style="list-style-type: none"> Exit standby by pressing the standby switch.











Standby To start the standby, keep the switch pressed for 5 seconds.



Note: Malfunctioning system possible after repeated standby. After repeatedly using the standby, turn power switch off and back on to reset the data storage.

3.7 Symbols and signs

The following symbols and signs can be found on the device:

Symbol	Meaning
	Electric shock hazard. Failure to observe this warning may result in loss of life, serious injury or damage or destruction of the device.
 Electrostatic Discharge	Electrostatic discharge hazard. Damages to system, device, or sensitive electronic components can occur.
 0.5 kg	Obey maximum load for leak tray during transportation, installation and operation.
	A warranty seal is affixed to some devices. For more information see „1.4.4 Warranty seal“, p. 2.
	The device is covered by the Waste Electrical and Electronic Equipment Directive (WEEE Directive). It may not be disposed of as unsorted municipal waste and must be collected separately. For more information see „10 Disposal“, p. 61.
	The device fulfills the product specific requirements of European directives.
	The device complies with the product-specific requirements of the United Kingdom.
	The device has successfully passed the TÜV tests for quality and safety. The TÜV Germany is a nationally recognized testing agency (NRTL) in Canada and the USA.
	The electromagnetic interference from the device is below the limits approved by the Federal Communications Commission (FCC).
	The device complies with the Australian EMV regulations.
CAN ICES-3 (B)	The device complies with Industry Canada license-exempt RSS standards.

Symbol **Meaning**



The device can be used for 15 years according to its intended use before there is a risk that the contained substances may escape and thereby pose a risk to the environment and health.

部件名称	有毒及危险物质或元素					
	铅	汞	镉	铬(VI)	多溴联苯	多溴二苯醚
印刷电路板	O	O	O	O	O	O
机电部件	O	O	O	O	O	O
电缆和电线	O	O	O	O	O	O
金属部件	X	O	O	O	O	O
塑料部件	O	O	O	O	O	O
电池	O	O	O	O	O	O
显示	n/a	n/a	n/a	n/a	n/a	n/a

O = 表示部件中所有同质金属中的有毒和危险物质含量低于SJ/T 11363-2006中描述的浓度极限要求。(表示部件中所有同质金属中的有毒和危险物质含量低于SJ/T 11363-2006中描述的浓度极限要求。*)

X = 表示部件中所有同质金属中的有毒和危险物质含量超过SJ/T 11363-2006中描述的浓度极限要求。(表示部件中所有同质金属中的有毒和危险物质含量超过SJ/T 11363-2006*中描述的浓度极限要求。*)

Part Name	toxic and hazardous substances or elements					
	Pb	Hg	Cd	Cr(VI)	PBB	PBDE
PCB	O	O	O	O	O	O
Electromechanical parts	O	O	O	O	O	O
Cables & wires	O	O	O	O	O	O
Metal Parts	X	O	O	O	O	O
Plastic parts	O	O	O	O	O	O
Batteries	O	O	O	O	O	O
Display	n/a	n/a	n/a	n/a	n/a	n/a

O = Indicates that the content of the toxic and hazardous substances in all homogenous Materials of the part is below the concentration limit requirements as described in SJ/T 11363-2006. (Indicates that the content of the toxic and hazardous substances in all homogenous Materials of the part is below the concentration limit requirements as described in SJ/T 11363-2006.*)

X = Indicates that the content of the toxic and hazardous substances in all homogenous Materials of the part is exceeds the concentration limit requirements as described in SJ/T 11363-2006. (Indicates that the content of the toxic and hazardous substances in all homogenous Materials of the part is exceeds the concentration limit requirements as described in SJ/T 11363-2006.*)

4. Installation and initial startup

Before you determine the operation site, read the chapter "Technical data" (see chapter 11 on page 62). There you will find all device-specific information on power supply, ambient conditions and humidity.



Note: The intended use is only ensured if the requirements for ambient conditions of the operating environment are met.

4.1 Unpacking

Process

Procedure

1. Place the packaging in such a way that the lettering on the label is in the correct position.
2. Check the packaging, the device and the accessories for transport damage.
3. Check the scope of delivery. In the event of incomplete delivery, contact Technical Support immediately.
4. When lifting, carrying or moving the device, grab the unit only from below on the sides. Do not hold onto front cover or leak tray, as these parts are loosely attached to the device.

Next steps

- Keep the included packing list for repeat orders.
- Keep the original packaging for safe storage or transportation.

4.2 Ambient conditions

4.2.1 Operation site

Observe the following requirements for the operation site so that the measurement results are not influenced:

- Place on a firm, level and straight surface.
- Protect against direct sunlight.
- Do not expose to air drafts such as air conditioning systems.
- Do not set up to other machines that cause floor vibrations.
- Keep from high frequency sources.
- Ensure adequate ventilation (see „4.2.3 Space requirements“, p. 16).
- Avoid temperature fluctuations (see „4.2.2 Ambient temperature“, p. 15).

4.2.2 Ambient temperature

If the ambient temperature of the device is abruptly changed (e.g. when it is installed in a cooling chamber), condensation will form inside the device and may cause damage to the device. Allow the device to acclimate for 3 h, before it is connected to the power supply and taken into operation.

4.2.3 Space requirements

- Make sure that the power plug on the power supply (wall socket or power strip) is always accessible, so that the device can be disconnected from the power supply.
- Ensure adequate ventilation around the device, otherwise it may overheat and malfunction:
 - Min. 5 cm distance if another device is set on one side.
 - Min. 10 cm distance if further devices are set on both sides.
 - At least 15 cm to the cooler fan on the rear.

4.3 Power supply

Power supply requirements

- Failure-free power supply: For failure-free operation, the electrical voltage must be free of fluctuations, residual currents, voltage peaks and electromagnetic interference. The device must receive sufficient voltage and reserve capacity.
- Check voltage: Only connect devices to a power supply whose voltage corresponds to the permissible voltage of the device.
- Power consumption: The nominal power of the connected devices must not exceed 50 % of the highest connected power capacity, since higher currents can flow briefly when the device is switched on.
- Main connection: The electrical power supply at the operation site must be connected directly to the nearest main power connection.
- Grounding: The connectors for the voltage must be grounded accordingly.

Power supply cables and plugs

- Original parts: For power supply, use the supplied power cable and plug to meet the specifications which are described in the chapter „11. Technical data“ on page 62. Detachable power cables are not allowed to be replaced with other cable types.
- Country-specific plugs: Before switching on the device, check whether the supplied plug is approved for your country. Overview of the device- and country-specific plug types from KNAUER: www.knauer.net/plugs.
- Power strips: If several devices are connected to one power strip, always consider the maximum power consumption of each device.
- Access to power supply: Make sure that the power plug on the power supply (wall socket or power strip) is always accessible, so that the device can be disconnected easily from the power supply.
- Damaged power supply cables and plugs: For safety reasons, damaged or faulty cables and plugs must not be used to connect the device to the power supply. Replace defective cables and plugs only with KNAUER accessories.

4.4 Connecting capillaries and fittings

All tubing and capillary, which connect the components of the pump, are pre-installed. Only the solvent bottles have to be connected and the pump has to be integrated into the flow of the HPLC system.

4.4.1 Connecting the solvent bottles

To connect the solvent bottles, tubing with pre-installed solvent filters is used. The tubing is connected to the device with flangeless fittings.



Note: Do not use any tools to tighten the fittings.

Procedure

Process

1. Slide the flangeless fitting ① over the tubing.
2. Slide the lock ring ② over the tubing.
3. Cap with the sealing ring ③. Note the direction of the lock ring, otherwise the sealing ring could be damaged. The thicker end of the lock ring must point into the direction of the fitting.
4. Manually fasten the flangeless fitting ④ to the device.

Figure

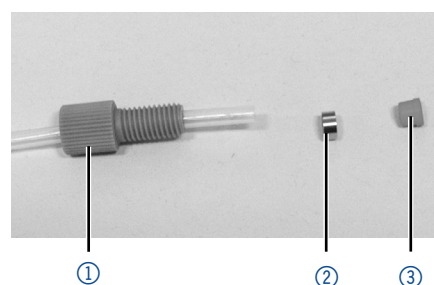

Fig. 6: Setup of a flangeless fitting

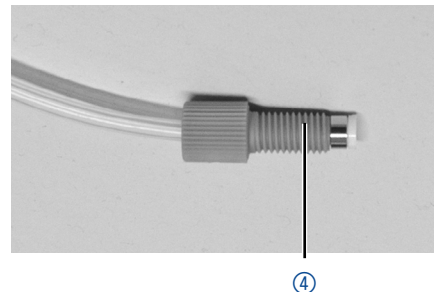

Fig. 7: Fully assembled flangeless fitting

4.4.2 Pre-installed capillaries

Pre-installed stainless steel and PEEK capillaries are color-coded according to their inner diameter.

Color	Material	Inner Diameter
Red marker	Stainless steel	0.1 mm
Blue marker	Stainless steel	0.25 mm
Black marker	Stainless steel	0.45 mm
Red stripe	PEEK	0.1 mm
Yellow stripes	Stainless steel	0.18 mm

Color	Material	Inner Diameter
Blue stripes	PEEK	0.25 mm
Orange stripes	PEEK	0.5 mm



Note: PEEK capillaries are not suitable for use with pure acetonitrile. Acetonitrile can cause capillaries to crack or rupture.

4.4.3 Integrating the pump into a HPLC system

The pump can be integrated into a HPLC system by connecting the pressure sensor (isocratic version) or the mixer (binary or quaternary version) and the HPLC system with capillaries.



Note: To integrate the pump into a system, note the ambient conditions found in the sections „4.2 Ambient conditions“ on page 15 and „11. Technical data“ on page 62 as well as the ambient conditions of other devices to be integrated into that system.

NOTICE

Component defect

Possible damage to the pump head due to over-tightened capillary fitting.

→ Note the torque of the screw connection.

Tool ■ Torque wrench

4.5 Isocratic pump

The figures show the installation plan for capillary and tubing on the isocratic versions of the pump.

Legend

- Connection solvent to pump
- Connection piston backflushing

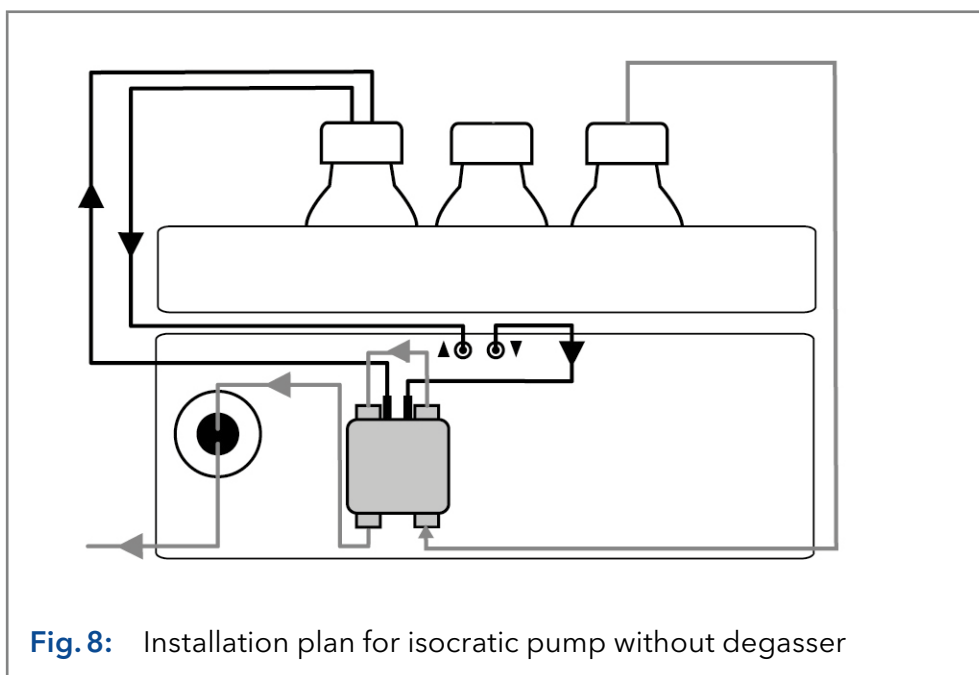
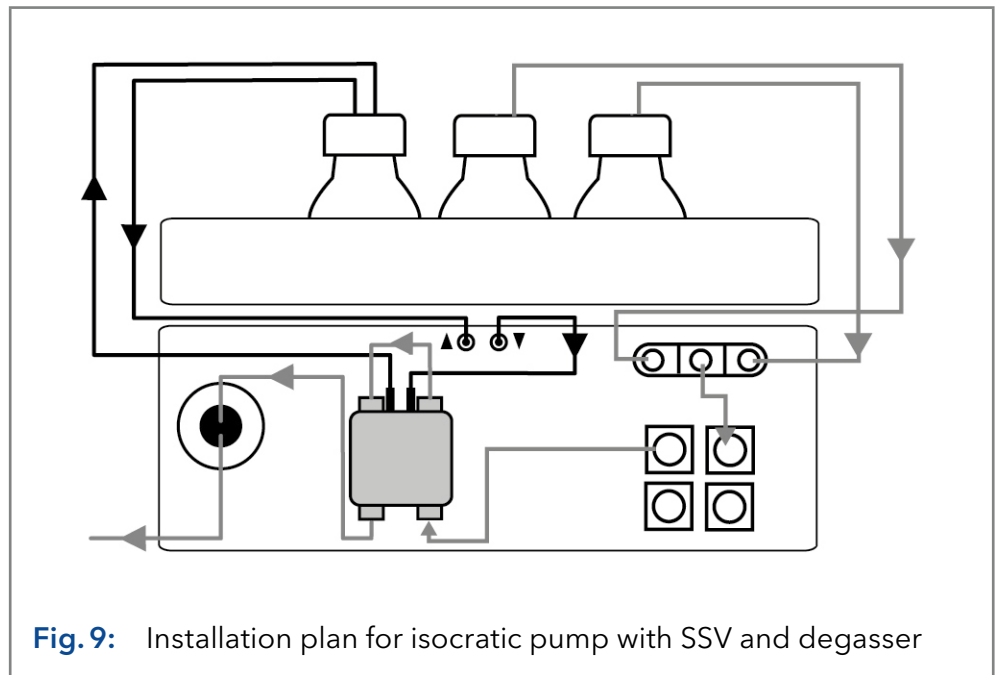

Fig. 8: Installation plan for isocratic pump without degasser

Legend

- Connection solvent to pump
- Connection piston backflushing



Piston backflushing The flushing solution is re-used. Since the flow path is circular, only one bottle is used for the flushing solution.

Solvent flow path The pump head takes the liquid from the bottle and conveys it to the pressure sensor.

4.5.1 Connecting the pump head to the solvent

- Prerequisites**
- The device has been switched off.
 - The power plug has been pulled.
 - The front cover has been removed.

- Material**
- Flangeless fitting

NOTICE

Device defect

Damage to pump head, device or system when inlet and outlet of the pump head are blocked.

- Remove the cap fittings from the inlet and outlet of the pump head prior to use.

Procedure**Process**

1. Slide the flangeless fitting over the tubing.
2. Insert the tubing into the free inlet ① on the bottom of the pump head.
3. Tighten the fitting by hand.

Figure

Fig. 10: Solvent line on pump head

Next step

Integrate the pump into the HPLC system (see „4.4.3 Integrating the pump into a HPLC system“, p. 18).

4.6 Binary pump

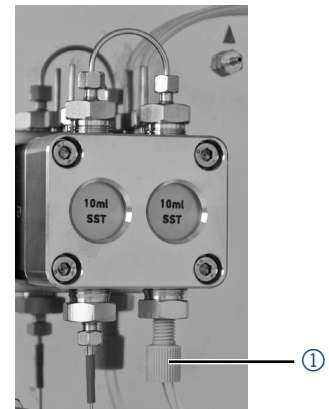
The figure shows the installation plan for capillary and tubing on the binary version of the pump.

Legend

- Connection solvent to pump
- Connection piston backflushing
- ① Solvent selection valve
- ② Degasser inlet
- ③ Degasser outlet

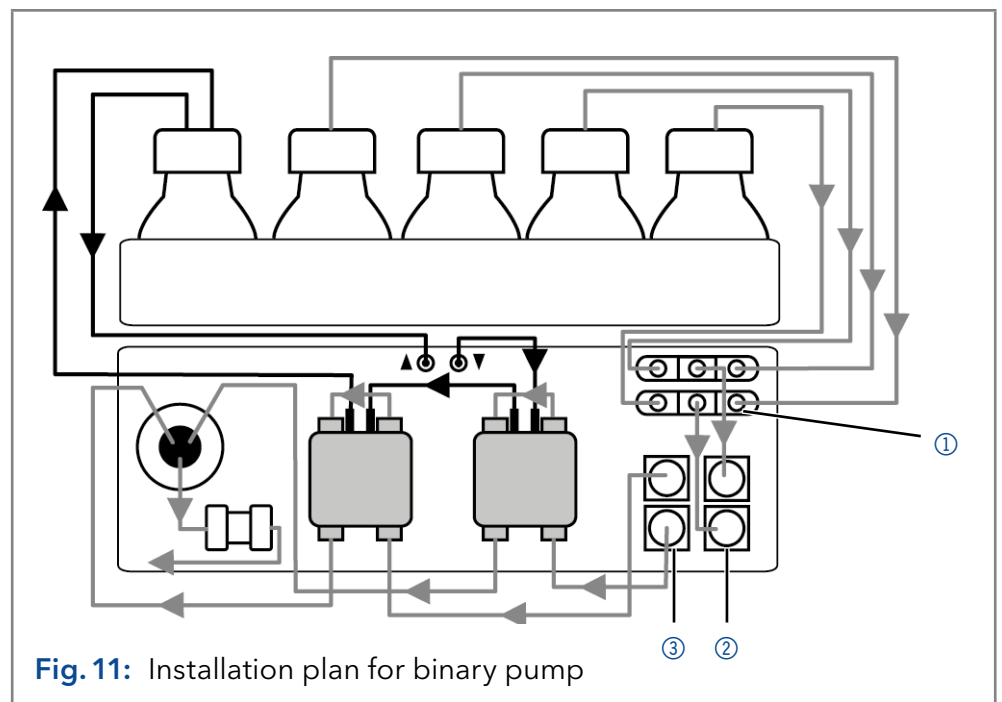

Fig. 11: Installation plan for binary pump

Piston backflushing

The flushing solution is re-used. Since the flow path is circular, only one bottle is used for the flushing solution.

Every pump head can operate with two different solvents. Both solvents are connected with the solvent selection valve ①. The solvents are transported into one pump head each and combined in the pressure sensor. The pressure sensor is connected to the mixer. The mixer is connected to the HPLC system.

4.6.1 Connecting the degasser (depending on version)

The degasser inlet ② is readily connected with the solvent selection valve ①. The degasser outlet ③ is readily connected with the pump heads (see Fig. 11). If the binary pump is equipped with a 4 channel degasser, two additional channels are available, e.g. for flushing solutions.

Solvent flow path

Both solvents are connected with the ② degasser inlet. The solvents are conveyed from the degasser into the pump head. From the pump head it is taken via the pressure sensor to the mixer. The mixer is connected to the HPLC system.



Note: The described flow path is not suitable for concentrated acids or bases (1 mol/l or greater), sodium azide, halogenated eluents, freons or hexafluoroisopropanol.

4.6.2 Connecting the pump head to the solvent

See chapter „4.5.1 Connecting the pump head to the solvent“ on page 19.

Next step

Integrate the pump into the HPLC system (see „4.4.3 Integrating the pump into a HPLC system“, p. 18).

4.6.3 Connecting the solvent selection valve to the solvent (depending on version)



Note: The solvent selection valve is readily connected to the 2-channel degasser.

The solvent selection valves allows selecting from two different solvents for each solvent channel, without having to re-install the tubing. For both solvent channels A and B, one of two solvents can be selected. Solvent A is connected to inlets A1 and A2, solvent B is connected to inlets B1 and B2.

Prerequisites

- The device has been switched off.
- The power plug has been pulled.
- The front cover has been removed.

Material

- Flangeless fitting

Procedure

Process

1. Connect the tubing from the four solvent bottles to the inlets A1, A2 and B1, B2.
2. Seal inlets not in use with cap fittings.

Figure

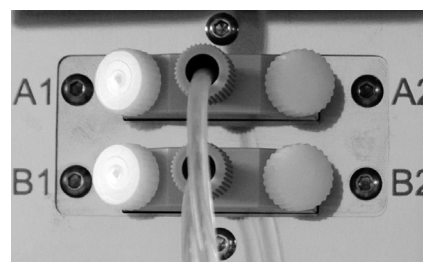

Fig. 12: Solvent selection valve with cap fitting

Next step Integrate the pump into the HPLC system (see „4.4.3 Integrating the pump into a HPLC system“, p. 18).

4.7 Quaternary pump

The figure shows the installation plan for capillary and tubing on the quaternary version of the pump.

Legend

- Connection solvent to pump
- Connection piston backflushing
- ① LPG valve block
- ② Degasser inlet
- ③ Degasser outlet

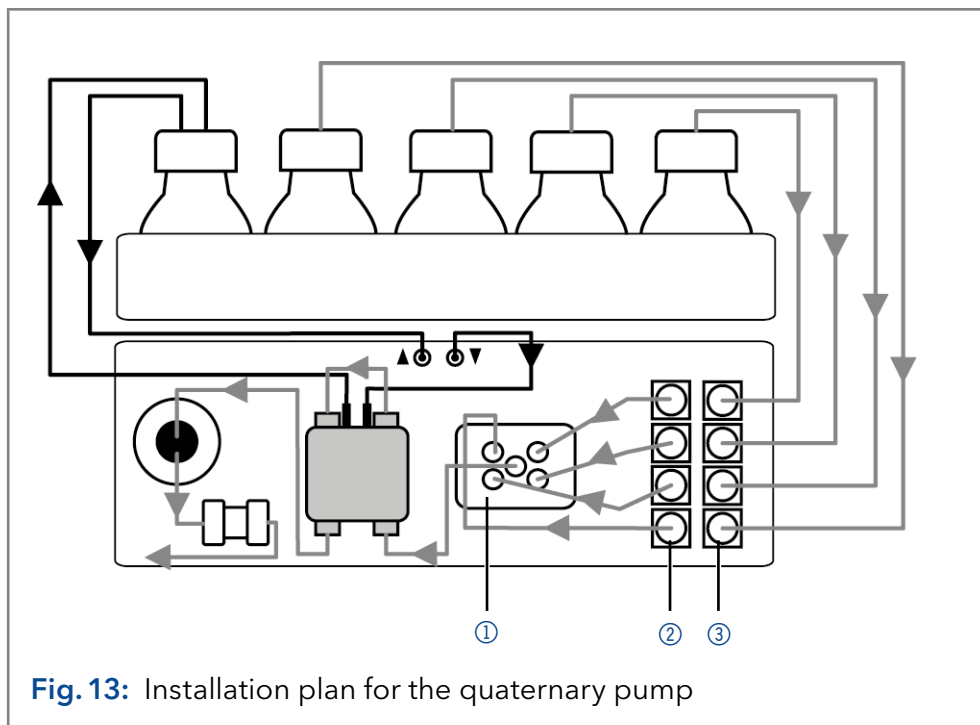

Fig. 13: Installation plan for the quaternary pump

Piston backflushing The flushing solution is re-used. Since the flow path is circular, only one bottle is used for the flushing solution.

4.7.1 Connecting the degasser (depending on version)

The degasser outlet ② is readily connected to the valve block ① (see Fig. 13).

Solvent flow path The four solvents are connected with the ③ degasser inlet. The solvent mixture is conveyed from the degasser via the valve block into the pump head. From the pump head it is taken to the mixer. The mixer is connected to the HPLC system.



Note: The described flow path is not suitable for concentrated acids or bases (1 mol/l or greater), sodium azide, halogenated eluents, freons or hexafluoroisopropanol.

4.7.2 Connecting the pump head to the solvent

See chapter „4.5.1 Connecting the pump head to the solvent“ on page 19.

Next step Integrate the pump into the HPLC system (see „4.4.3 Integrating the pump into a HPLC system“, p. 18).

4.7.3 Connecting the 4-channel degasser to the solvent

The 4-channel degasser contains four degassing chambers. Each degassing chamber has an inlet and an outlet on the front of the pump.

NOTICE

Device defect

Very high pressures can damage the degasser membrane. The membrane can withstand a maximum pressure of 7 bar.

→ Never connect the degasser to the pump outlet.

- Prerequisites**
- The device has been switched off.
 - The power plug has been pulled.
 - The front cover has been removed.

- Material**
- Flangeless fitting

Procedure

Process

1. Connect the tubing from the four solvent bottles to the inlets A, B, C, and D of the degasser.
2. Seal inlets not in use with cap fittings.

Figure

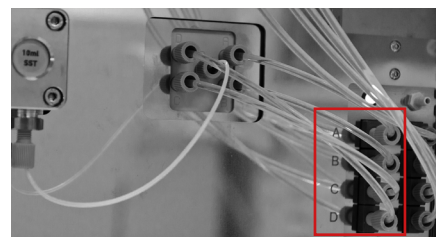

Fig. 14: 4-channel degasser with valve block

- Next step** Integrate the pump into the HPLC system (see „4.4.3 Integrating the pump into a HPLC system“, p. 18).

4.7.4 Connecting the valve block



Note: Note the instructions on how to install the flangeless fitting in section „4.4 Connecting capillaries and fittings“ on page 17.

The valve block inlets ① are pre-installed. If the central outlet connection has to be changed, e.g. you want to install different capillaries, note that at least two of the outer flangeless fittings on the valve block are loosened in order to be able to install connection in the center by hand.

4.8 Connecting the piston backflushing

The piston backflushing removes salts and other substances from the area behind the pump head seals.

To do this, connect a bottle with flushing solution to the flush pump and the piston backflushing. The silicone tubing between the piston backflushing and the flush pump are pre-installed.

Designation Inlet and outlet of the flush pump are located on the front of the device. The flush pump is inside of the device and not visible from the outside.



Fig. 15: Inlet symbol



Fig. 16: Outlet symbol

Prerequisite

- The pump has been set up at the site of operation.
- The pump has been switched off.

Material

- Silicone tube

Procedure

Process

1. Plug one silicone tube ② onto the inlet ③ of the flush pump.
2. Connect the tube to the flushing solution bottle.
3. Plug a second silicone tube onto a vacant capillary connector ① of the flush pump and connect to the flushing solution bottle.

Figure

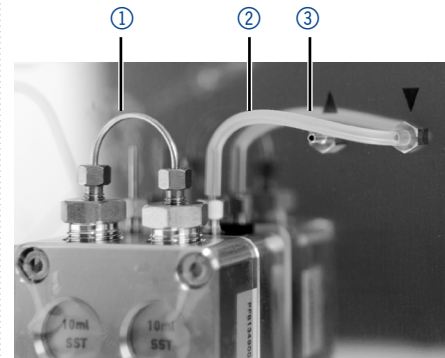

Fig. 17: Connecting piston backflushing

Select a suitable solvent in the piston backflushing. The solvent used for the flushing depends on the application and the used solvent in the pump:

Solvent in the pump	Piston backflushing
Reverse phase solvents	50% isopropanol or ethanol with 50% water (v/v).
Normal phase solvents	100% isopropanol
Buffers with high salt concentrations	Rinse with water containing 5% ethanol or isopropanol



Note: Never fill the backpiston flushing with normal phase solvents like heptan or hexan.



Note: Fluctuations in the level of the backpiston cylinder may indicate a problem with the seals or connections of the pump head.

4.9 Connecting the leak management

The leak management consists of the leak sensor and the drainage system. The drainage system ensures that escaping liquids flow into a waste bottle. If there is too much liquid, the red LED starts flashing. Both the device and the data acquisition via chromatography software are stopped.

Prerequisites ■ Remove the front cover.

Procedure

Process

Figure

1. Carefully push the funnel ① into the center opening of the capillary guide ②.

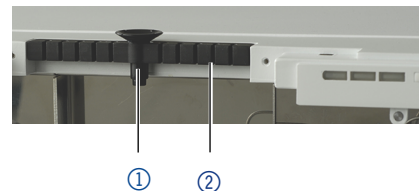

Fig. 18: Funnel and capillary guide

2. Push the long ending of the first nozzle ④ into the hose ③.

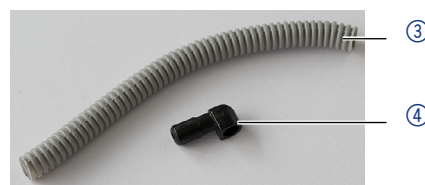

Fig. 19: Hose and nozzle

3. Push the nozzle onto the funnel.
4. Push the other end of the hose onto the nozzle ⑤ of the leak tray.



Fig. 20: Hose connected to device

5. Attach the waste nozzle ⑥ to the bottom unit.
6. Attach the waste hose to the waste nozzle and connect it to the waste container.
7. Place the waste container below the devices.

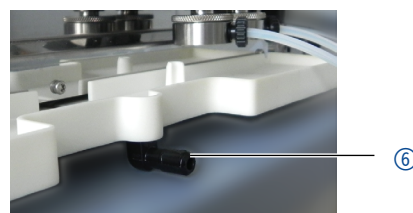

Fig. 21: Leak tray with nozzle

Next steps ■ Attach the front cover.

4.10 Control

The pump can be operated in two ways:

- Via the pin header (Analog-IN connection with WAGO plug)
- As part of a LAN, via the LAN connector of the router

All connectors for external control are located on the rear side of the pump.

Legend

- ① Service board drive B (HPG version only, used exclusively for direct control of drive B via KNAUER Service Tool)
- ② Events connector
- ③ LAN connector
- ④ Remote connector

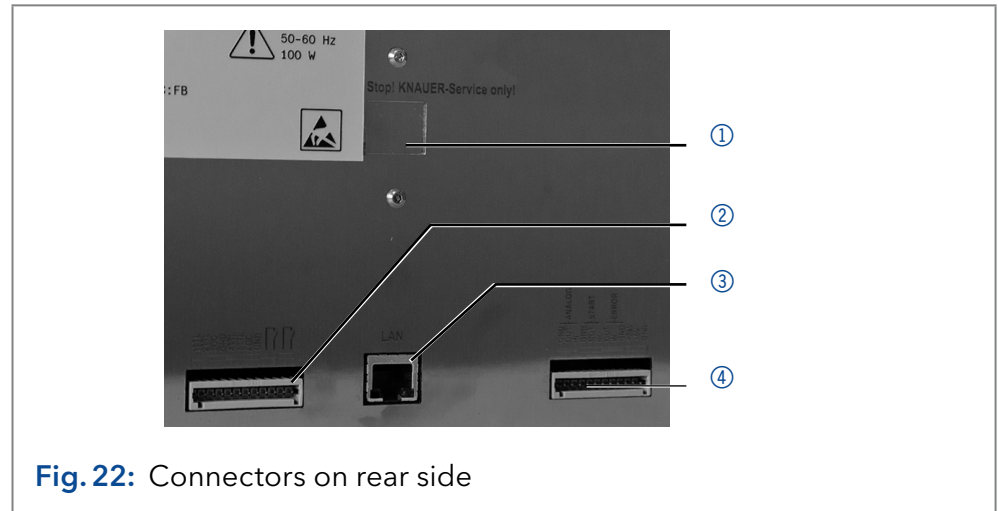

Fig. 22: Connectors on rear side

Note: HPLC devices from KNAUER only work with IP addresses, which have been assigned by IPv4. IPv6 is not supported.

This chapter describes how to set up a chromatography system in a local area network (LAN) and how a network administrator can integrate this LAN into your company network. The description applies to the operating system Windows® and all conventional routers.

Note: When using PurityChrom®, static IP addresses are needed (see „4.10 Control“, p. 26).

4.10.1 Setting up LAN

To set up a LAN, we recommend to use a router. That means the following steps are required:

	Process
Procedure	1. On the computer, go to the control panel and check the LAN properties.
	2. Hook up the router to the devices and the computer.
	3. Set up the router for the computer network.
	4. Install the chromatography software.
	5. Switch on the device and run the chromatography software.

Next steps Configure LAN properties (see section „4.10.2“).

4.10.2 Configuring LAN settings

The LAN uses only one server (which is normally the router) from that the devices automatically receive their IP address.

Prerequisites

- In Windows, power saving, hibernation, standby, and screen saver must be deactivated.
- In case you use an USB-to-COM box, the option "Allow the computer to turn off this device to save power" in the device manager must be deactivated for all USB hosts.
- Applies to all LAN devices: Disable the setting for the network adapter in device manager "Allow the computer to turn off this device to save power".

Process

Procedure

1. In Windows, open <Network and Sharing Center>.
2. Double-click on <LAN connection>.
3. Click on the button <Properties>.
4. Select <Internet Protocol version 4 (TCP/IPv4)>.
5. Click on the button <Properties>.
6. Check the settings in the tab <General>. The correct settings for the DHCP client are:
 - a) Obtain an IP address automatically
 - b) Obtain DNS server address automatically
7. Click on the button <OK>.

Next steps Connect devices (see section „4.10.3“).

4.10.3 Connecting devices with LAN

A router ② has several LAN ports ③ and one WAN port ④ that can be used to integrate the LAN into a wide area network (WAN), e.g. a company network or the Internet. In contrast, the LAN ports serve to set up a network from devices ① and a computer ⑤. To avoid interference, we recommend operating the chromatography system separately from the company network.



Note: You will find patch cables for each device and the router in the accessories kit. To connect the router to a LAN, an additional patch cable is required, which is not supplied within the scope of delivery.

- ① Devices
- ② Router
- ③ LAN ports
- ④ WAN/Internet connection
- ⑤ Computer

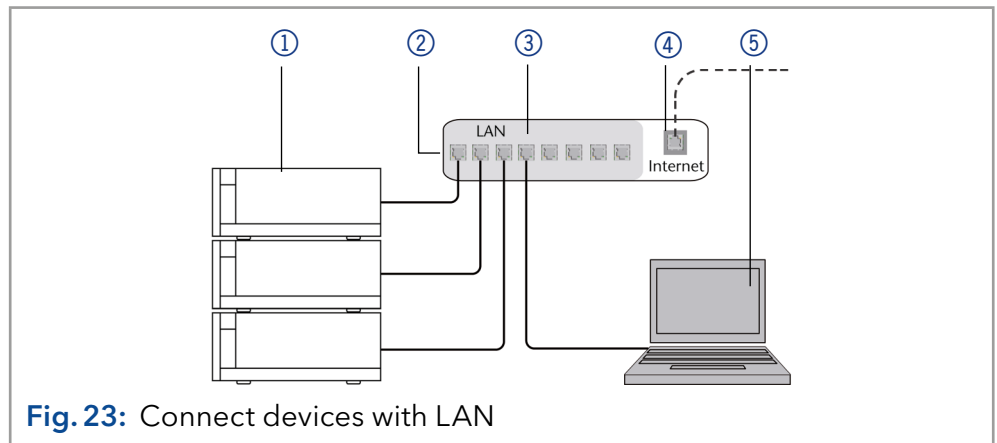

Fig. 23: Connect devices with LAN

- Prerequisites**
- The computer is switched off.
 - There is a patch cable for each device and the computer.

Process

- Procedure**
1. Use the patch cable to connect the router and the computer. Repeat this step to connect all devices.
 2. With additional patch cables, connect all devices individually with the router.
 3. Use the power supply to connect the router to the mains power system.

Next steps Set the router properties (see section „4.10.4“).

4.10.4 Configuring the router

The router is preset at the factory. Information about address, user name and password is noted in the router manual: www.knauer.net/router.

Process

- Procedure**
1. To open the router configuration, start your Internet browser and enter the IP address (does not apply for all routers).
 2. Enter user name and password.
 3. Configure the router as DHCP server.
 4. In the router configuration, check the IP address range and make changes if necessary.



Note: If the IP address range has been changed, it is essential to note this information on the router.

Result Once the router has assigned IP addresses to all devices, the chromatography software can be used to remotely control the system.

4.10.5 Integrating LAN into the company network

A network administrator can integrate the LAN into your company network. In this case you use the WAN port of the router.

- Prerequisites**
- There is a patch cable for the connection.

	Process
Procedure	1. Make sure that there is no overlap between the IP addresses of the router and the corporate network.
	2. In case of an overlap, change the IP address range of the router.
	3. Use the patch cable to connect the router WAN port to the company network.
	4. Restart all devices, including the computer.
Result	The LAN is now integrated into the company network.

4.10.6 Controlling several systems separately in LAN

Devices connected to a LAN communicate through ports, which are part of the IP address. If more than one chromatography system is connected to the same LAN and you plan on controlling them separately, you can use different ports to avoid interference. Therefore, the port number for each device must be changed and this same number must be entered into the device configuration of the chromatography software. We recommend to use the same port number for all devices in the same system.



Note: The port is set to 10001 at the factory. You must use the same numbers in the device configuration of the chromatography software as in the device, otherwise the connection fails.

	Process
Procedure	1. Find out port number and change it on the device.
	2. Enter the port number in the chromatography software.
Result	The connection is established.

4.11 Setting IP addresses via software



Note: Check the IT security standards for your lab before intervening in the LAN settings.

PurityChrom® Static IP addresses are required to run certain chromatography software, e.g. Purity Chrom®. For a comprehensive overview on how to set static IP addresses for PurityChrom®, refer to the document „PurityChrom® Installation Guide“ on the PurityChrom® installation CD.

For Mobile Control and Firmware Wizard it is possible to set a fixed (static) or dynamic (DHCP) IP address via software.

4.11.1 Mobile Control: Setting a static IP address





Note: The device is preset to a dynamic address (DHCP). To ensure a constant LAN connection between the chromatography software and the instrument, we recommend switching the instrument to a static IP address for certain applications. More information about LAN settings can be found in the [Mobile Control Software Instructions](#) (document no. V6851-2).

Prerequisites ■ The device is switched on.

- Mobile Control is installed and running.
- The connection between Mobile Control and the device has been established.

Procedure**Process**

1. In Mobile Control, click  <Settings>.
2. On the <General> tab, choose the device name.
3. In <Network Settings>, choose the setting <Static> ① .
4. Enter the IP address into the text box <IP Address> ② .
5. If necessary, change the subnet mask and the gateway ③ .
6. Click  in the top right corner.
7. Restart the device (recommended).

- ① IP address mode
- ② Text box for IP address
- ③ Text field for subnet mask/gateway

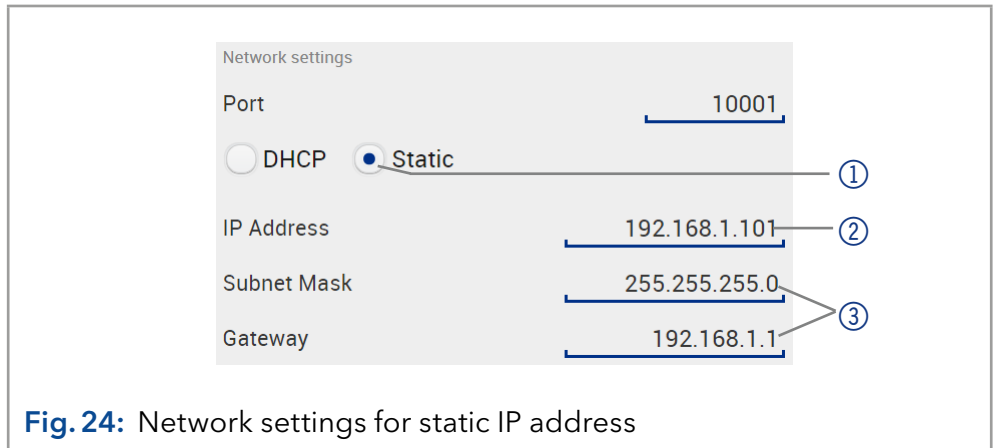



Result The device is now accessible via the static IP address.

4.11.2 Mobile Control: Setting a dynamic IP address via device name

Prerequisites

- The device is switched on.
- Mobile Control is installed and running.
- The connection between Mobile Control and the device has been established.

Procedure**Process**

1. In Mobile Control, click  <Settings>.
2. On the <General> tab, choose the device.
3. In <Network Settings>, choose the setting <DHCP> ① .
4. Click  in the top right corner.
5. Restart the device (recommended).

① IP address mode

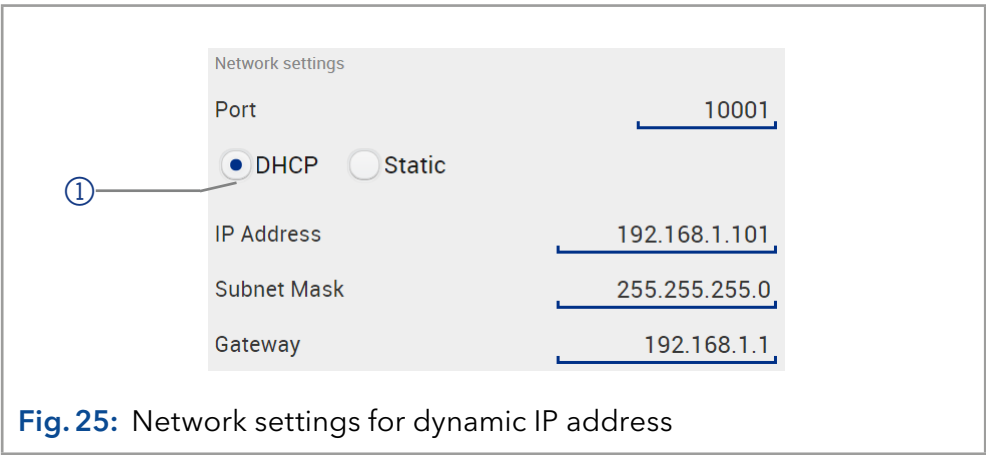

Fig. 25: Network settings for dynamic IP address

Result The device is now accessible via a dynamic IP address.

4.11.3 Mobile Control: Setting a dynamic IP address via device serial number

- Prerequisites**
- The device is switched on.
 - Mobile Control is installed and running.
 - The connection between Mobile Control and the device has been established.

Process

- Procedure**
1. In Mobile Control, click <Settings>.
 2. In <Network Settings>, click <Reset>. The windows <Reset communication settings> opens.
 3. Enter the serial number of the device into the text field.
 4. Click <OK>. The device is now reset to default settings.
 5. Restart the device (recommended).

Result The device is now accessible via a dynamic IP address.

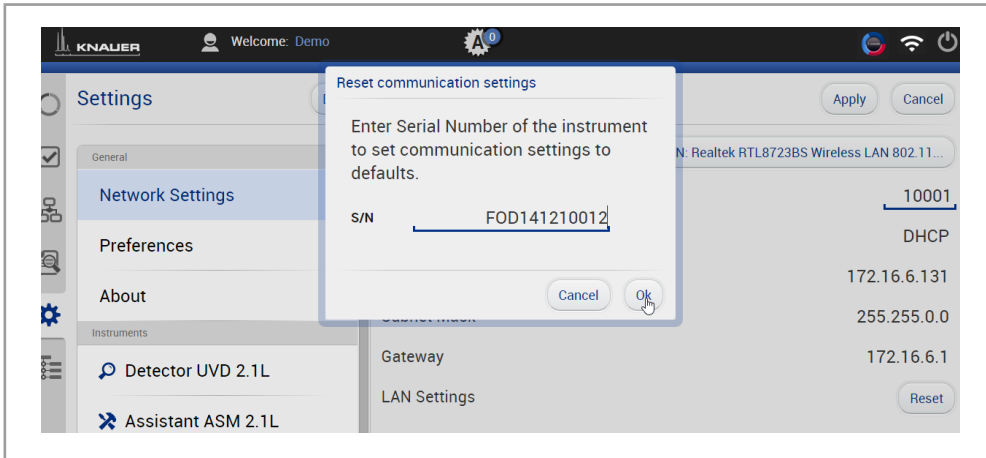

Fig. 26: Reset device to default settings

4.11.4 Firmware Wizard: Setting a static IP address



Note: More information about LAN settings can be found in the Mobile Control Software Instructions in the chapter "Firmware Wizard" (document no. V6851-2).

- ① Text box for serial number of the device
- ② Setting IP address manually
- ③ Text box for IP address
- ④ Text box for subnet mask & gateway
- ⑤ Confirm changes

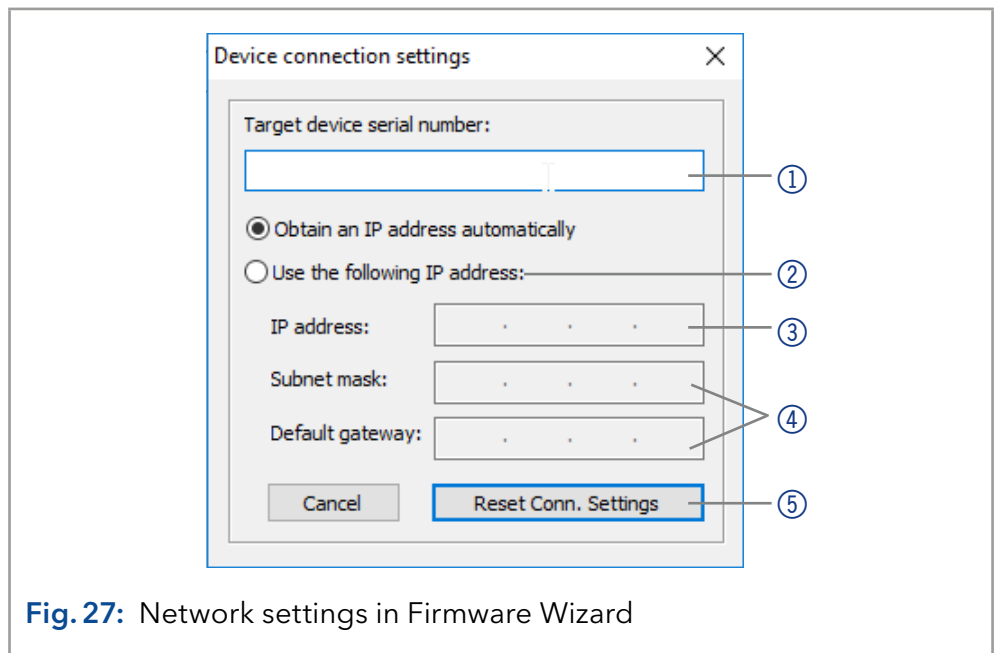

Fig. 27: Network settings in Firmware Wizard

Prerequisites

- The device is switched on.
- Firmware Wizard is installed and running.

Process

Procedure

1. In Firmware Wizard, click <Reset LAN Settings...>.
2. The window <Device connection settings> opens. Enter serial number of the device into the text field <Target device serial number> ①.
3. Select option <Use the following IP address> ②.
4. Enter the IP address into the text field <IP address> ③.
5. Optionally, adjust subnet mask and gateway ④.
6. Click <Reset Conn. Settings> ⑤ to accept changes.
7. Restart the device (recommended).

Result The device is now accessible via the static IP address.

4.11.5 Firmware Wizard: Setting a dynamic IP address

Prerequisites

- The device is switched on.
- Firmware Wizard is installed and running.

Process**Procedure**

1. In Firmware Wizard, click <Reset LAN Settings...>.
2. The window <Device connection settings> opens. Enter serial number of the device into the text field <Target device serial number> ① .
3. Select option <Obtain an IP address automatically> ② .
4. Click <Reset Conn. Settings> ⑤ to accept changes.
5. Restart the device (recommended).

Result The device is now accessible via a dynamic IP address.

4.12 Remote control

4.12.1 Connector assignment

Remote connector

- For receiving start, control, and error signals from external devices
- For sending start, control and error signals to external devices

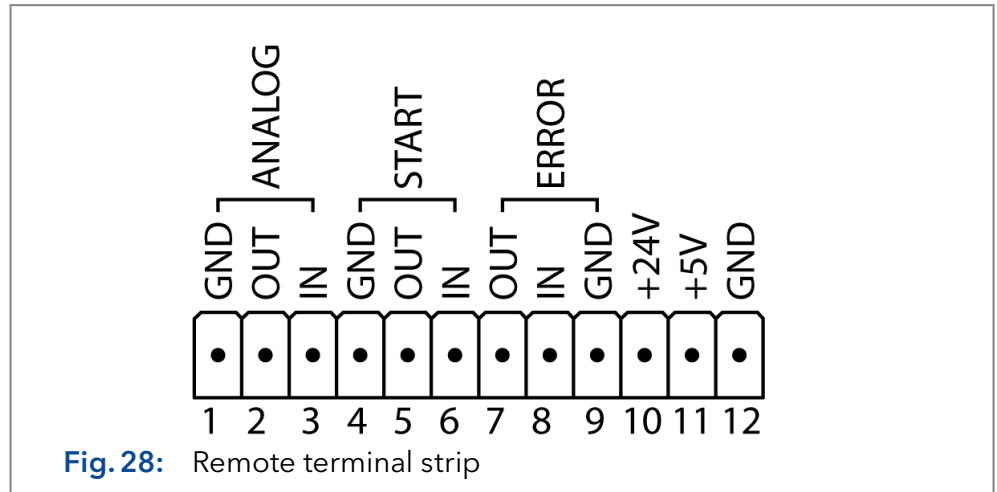

Signal	Explanation
Analog GND	Reference point of the voltage at the signal inputs.
Analog OUT	Voltage range 0-5 V, scalable
Analog IN	Voltage range 0-10 V 10 V according to maximum flow rate
Start GND	Reference point of the voltage at the signal inputs.
Start OUT	TTL Output Levels: <ul style="list-style-type: none"> ■ passive 5 V ■ active 0 V
Start IN	TTL Input <ul style="list-style-type: none"> ■ Low active Secure switching threshold at least 10 mA After receiving a signal (short-circuit to ground) from an external device, the device starts. If controlled with software, an electronic trigger is send through the LAN.
Error OUT	TTL Output Levels: <ul style="list-style-type: none"> ■ passive 5 V ■ active 0 V

Signal	Explanation
Error IN	TTL Input <ul style="list-style-type: none"> Low active Secure switching threshold at least 10 mA After receiving a signal (short-circuit to ground) from an external device, an error message appears and the device stops.
Error GND	Reference point of the voltage at the signal inputs.
+24V	Event-controlled switching of 24 V against GND Protection: 24 V-200 mA
+5V	Provides a voltage of 5 V with respect to GND. This makes it possible to supply a consumer that is switched by an EVENT. Protection: 5 V-50 mA
GND	Reference point of the voltage at the signal inputs.

Events connector







For test purposes or in some other cases, it can make sense to manually enter these signals:

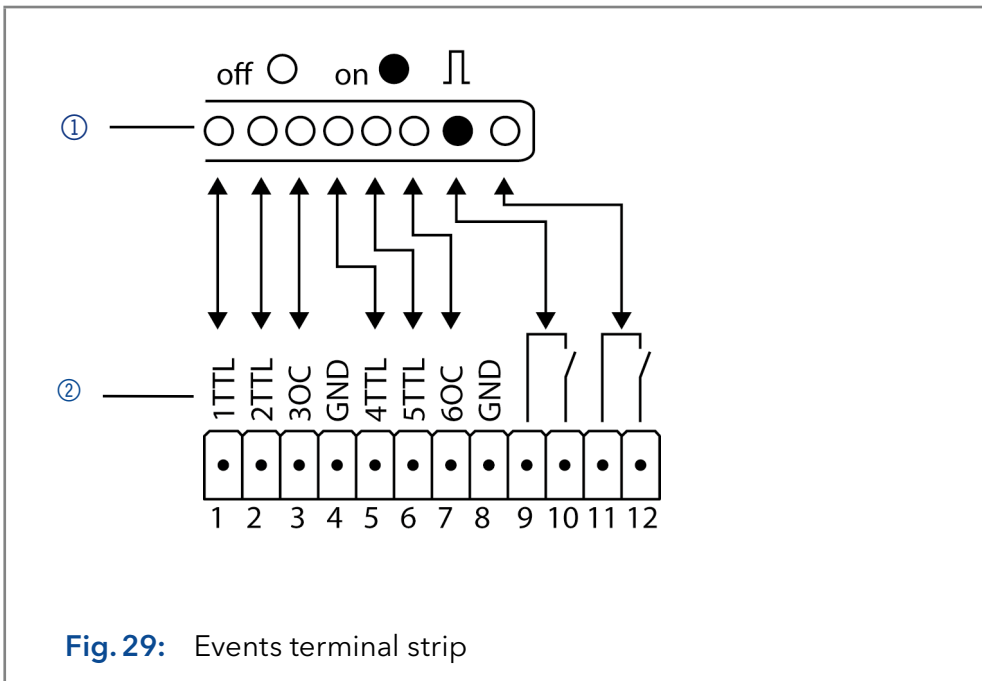







- Sending control signals (Events) to external devices
- Opening and closing contacts
- Activating 500 ms pulses

Legend

- ① Display
- ② Events terminal strip



Assignment	connection	Function
1TTL		TTL Output Levels: <ul style="list-style-type: none"> ■ passive 0 V <input type="checkbox"/> ■ active 5 V <input type="checkbox"/> Pulse: 5 V for at least 1 000 ms 
2TTL		TTL Output Levels: <ul style="list-style-type: none"> ■ passive 0 V <input type="checkbox"/> ■ active 5 V <input type="checkbox"/> Pulse: <ul style="list-style-type: none"> ■ 5 V for at least 1 000 ms 
3OC		TTL-compatible output Levels: <ul style="list-style-type: none"> ■ passive 5 V <input type="checkbox"/> ■ active 0 V <input type="checkbox"/> Pulse: <ul style="list-style-type: none"> ■ 5 V for at least 1 000 ms 
GND		Reference point of the voltage at the signal inputs.
4TTL		TTL Output Levels: <ul style="list-style-type: none"> ■ passive 0 V <input type="checkbox"/> ■ active 5 V <input type="checkbox"/> Pulse: 5 V for at least 1 000 ms 
5TTL		TTL Output Levels: <ul style="list-style-type: none"> ■ passive 0 V <input type="checkbox"/> ■ active 5 V <input type="checkbox"/> Pulse: <ul style="list-style-type: none"> ■ 5 V for at least 1 000 ms 
6OC		TTL-compatible output Levels: <ul style="list-style-type: none"> ■ passive 5 V <input type="checkbox"/> ■ active 0 V <input type="checkbox"/> Pulse: <ul style="list-style-type: none"> ■ 5 V for at least 1 000 ms 

Assignment	connection	Function
	GND	Reference point of the voltage at the signal inputs.
		<p>Relay Contact</p> <p>The contact is on a floating basis. Its setting depends on the settings in the software.</p> <p>Steady-rate signal:</p> <ul style="list-style-type: none"> passive = open relay contact  active = closed relay contact  <p>Pulse:</p> <ul style="list-style-type: none"> Closed relay contact for at least 1 000 ms <p>Permissible load of the relay contact: 1 A/ 24 V DC </p>
		<p>Relay Contact</p> <p>The contact is on a floating basis. Its setting depends on the settings in the software.</p> <p>Steady-rate signal:</p> <ul style="list-style-type: none"> passive = open relay contact  active = closed relay contact  <p>Pulse:</p> <ul style="list-style-type: none"> Closed relay contact for at least 1 000 ms <p>Permissible load of the relay contact: 1 A/ 24 V DC </p>

4.12.2 Connecting the pin header

To control one device through another, the pin header is used. To use remote control, you have to connect cables to the pin header. The single ports are used to exchange control signals.

- Prerequisites**
- The device is switched off.
 - The power plug is disconnected from the device.
- Tools**
- Depressor tool

NOTICE

Electronic defect

Connecting cables to the multi-pin connector of a switched on device causes a short circuit.

- Turn off the device before connecting cables.
- Pull the power plug.

NOTICE

Electronic defect

Electrostatic discharge can destroy the electronics.

- Wear a protective bracelet against electrostatic discharge and ground.

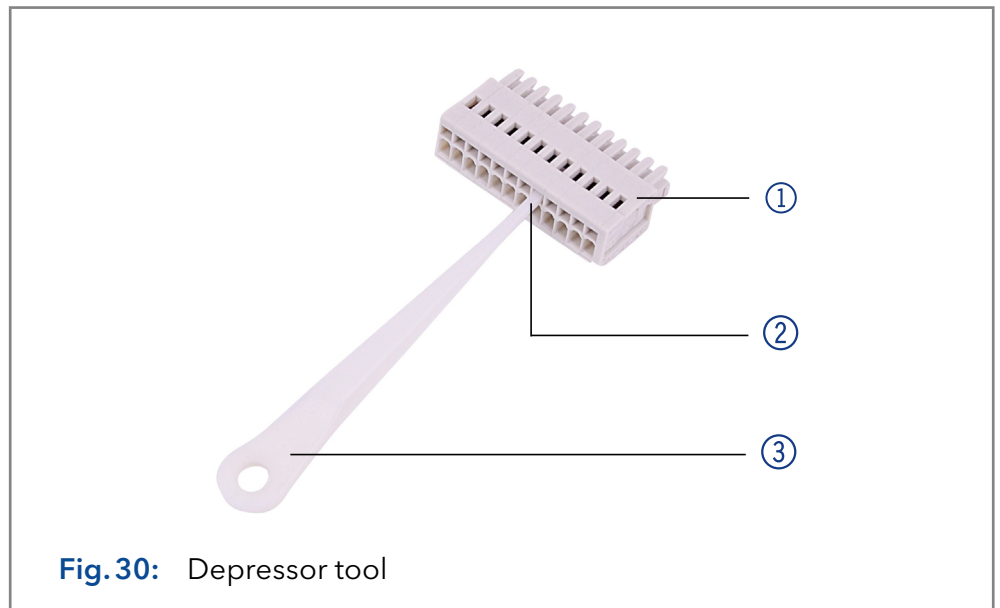

Process

1. Insert the depressor tool ③ in an upper small opening at the front of the pin header ①.
2. Insert the cable into the opening ② underneath the inserted depressor tool
3. Pull out the depressor tool.

Next steps

- Check whether the cables are tightly attached.
- Press the pin header onto the connector.
- Finish the installation.
- Bring the device into operation.

4.13 Analog control

Analog ports serve for exchanging analog control signals. Reference point for the signals is the connector „ground“ GND.

- OUT: Device sends signal.
- IN: Device receives signal.

5. Operation

5.1 Initial operation

Use this checklist to check if the pump is ready for initial operation:

- Device is positioned in the correct location.
- The power plug has been connected.

If the device is part of an HPLC system, you should also note the following:

- The network connection to the router is established.
- The chromatography software has been installed by KNAUER or a company authorized by KNAUER.
- The capillaries have been connected.



Note: Flush the pump prior to switching it on to remove air from capillaries and tubings (see „5.2 Purging the pump“ on p. 39).

5.1.1 Pump head running-in



Note: It is mandatory to perform a running-in procedure after a pump head maintenance, or if new pump heads are installed on a pump.

All pump heads were filled with isopropanol prior to delivery. Make sure to connect the correct solvent as described in the specification table found in the supplement „[Running-In procedure for pump heads](#)“ (V6894).

If a pump was not in operation for a long time, e.g. after shipment, a running-in procedure might be necessary to obtain the best pump performance. The pump head underwent this procedure during the manufacturing process.

If the pump is performing within specification, or during intensive operation, it is not necessary to perform this procedure.

5.2 Purging the pump

Before the pump can be used, it must be purged to remove excess air in the capillaries.

Flush the pump in the following cases:

When is flushing required?

- At initial startup to eliminate air bubbles in hoses and capillaries.
- When changing solvents.
- After using buffer solutions to eliminate salt residues.
- Before turning off, if you do not plan to restart the device within shortly.

Prerequisites

- The installation has been completed.
- The capillaries and tubings have been connected.
- The pump has been switched on and is in „flow mode“.

Tool

- Syringe with Luer lock

Use the flushing solvent to be used in the following application.



Note: The purging process may take a while during initial operation because the solvent tubes are filled with liquid for the first time.



Note: If a buffer solution is used, pay attention to choosing a solvent for flushing in which the buffer solution is soluble.

NOTICE

Column defect

Damage to the column due to purging.

- Open the venting screw.
- Remove the column.

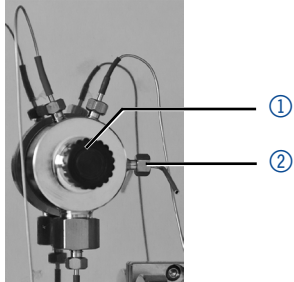
Procedure	Process	Figure
	<ol style="list-style-type: none"> 1. Open the venting screw ① of the pressure sensor. 2. Connect the syringe with the silicone tubing to the outlet ②. 3. Start the pump using the software (option: <i>PURGE</i>) with a medium flow rate (50 % of the maximum flow). 4. With the syringe, extract fluid through the purge port ②. 5. If the extracted fluid flows continuously, stop suction and close the venting screw ①. 	 <p>Fig.31: Venting screw of the pressure sensor</p>

The purging process of the pump is limited to a maximum pressure of 5 MPa. If this value is exceeded during the purging process, the pump switches off automatically. If you are using very small hoses and capillaries, the pressure can be too high.

For how long is purging required?

If there are air bubbles in the capillaries, the flow pulsates. As soon as the flow is constant, the pump is purged and the purging process can be stopped. The duration for purging depends on capillary and hose length as well as the flow rate.

5.3 Switch-on

After switching on the pump, the piston backflushing automatically flushes for 15 seconds.

Prerequisite ■ The installation has been completed.

NOTICE

Device defect

Changes of the environmental temperature cause condensation inside the device.

→ Allow device to acclimate for 3 h before connecting to power supply and taking into operation.

NOTICE

Component defect

Possible damage to the pump head due to dry running.

→ Make sure that solvent flows through the pump head and piston backflushing.

Procedure

1. Connect the power cable of the device to the power supply.
2. Switch the power supply on.
3. Wait until the pump has completed the self-test.
4. Start the pump at a medium flow rate.

Next step Operate the pump.

5.4 Software control

There are several options for controlling the device:

- With chromatography software
- With KNAUER Mobile Control



Note: It is not possible to use two control methods simultaneously. If the device is connected to the software, it cannot be controlled via Mobile Control.

5.4.1 Controlling with chromatography software

To operate the device with software, you have to establish a connection between the LAN port and a computer. You find a detailed description on chromatography software in the corresponding instructions.

5.4.2 Controlling with Mobile Control

The Mobile Control is an app which can be installed on your computer or tablet. To control the device using the Mobile Control, connect the computer or tablet with operating system Windows 10 to a wireless LAN router. The firmware version of the pump must be V01.02 or higher. You find a detailed description in the Mobile Control Instructions (V6851-2).

6. Functionality tests



Note: Standard processes regarding IQ and OQ in single devices may be handled differently in individual cases.

6.1 Installation Qualification (IQ)

The customer may request the Installation Qualification, which is free of charge. In case of a request, the Technical Support of KNAUER or a provider authorized by KNAUER performs this functionality test during the installation.

The Installation Qualification is a standardized document that includes the following:

- Confirmation of flawless condition at delivery
- Check if the delivery is complete
- Certification on the functionality of the device

You can either use the „Installation Qualification (IQ)“ document attached to this instruction manual or download a digital version from our website:



6.2 Operation Qualification (OQ)

The Operation Qualification includes an extensive functionality test according to KNAUER standard OQ documents. The Operation Qualification is a standardized document and free of charge. It is not part of the delivery. Please contact the Technical Support in case of a request.

The Operation Qualification includes the following:

- Definition of customer requirements and acceptance terms
- Documentation on device specifications
- Device functionality check at installation site

Test intervals To make sure that the device operates within the specified range, you should test the device regularly. The test intervals depend on the usage of the device.

Execution The test can be carried out either by the Technical Support of KNAUER or by a provider authorized by KNAUER (for a fee). For further information visit our website:



7. Troubleshooting

First measures:

- Check all cables and fittings.
- Check if air has gotten into the supply lines.
- Check the device for leakages.

Further measures:

- Compare occurring errors with the list of possible errors (see below).
- Contact the Customer Support.

7.1 LAN

Go through the following steps, in case no connection between the computer and the devices can be established. Check after each step if the problem is solved. If the problem cannot be located, call the Technical Support.

1. Check the status of the LAN connection in the Windows task bar:



If no connection was established, test the following:

- Is the router switched on?
 - Is the patch cable connected correctly to the router and the computer?
2. Check the router settings:
 - Is the router set to DHCP server?
 - Is the IP address range sufficient for all the connected devices?
 3. Check all connections:
 - Are the patch cable connected to the LAN ports and not the WAN port?
 - Are all cable connections between devices and router correct?
 - Are the cables plugged in tightly?
 4. If the router is integrated into a company network, pull out the patch cable from the WAN port.
 - Can the devices communicate with the computer, even though the router is disconnected from the company network?
 5. Turn off all devices, router, and computer. First switch on the router and wait until it has successfully completed its self-test. Firstly, turn on the router and secondly turn on the devices and the computer.
 - Has this been successful?
 6. Replace the patch cable to the device with that no connection could be established.
 - Has this been successful?
 7. Make sure that the IP port of the device matches the port in the chromatography software.

7.2 Possible problems and solutions

Issue	Solution
Device cannot be switched on.	Inspect the power cable to ensure that it is plugged into the power supply.
When purging, the pump switches off.	Check if the venting screw on the pressure sensor is opened.
Pump does not transport solvent.	<ul style="list-style-type: none"> ■ Purge the pump head to remove the air bubbles. ■ Clean the check valves. ■ Exchange the check valves. ■ If the pump head seals are defective, solvent enters the piston backflushing; inform the Technical Support. ■ Pump head maintenance is required.
Pressure and flow rate variations	<ul style="list-style-type: none"> ■ Purge the pump head to remove the air bubbles. ■ Always tighten the inlet screw fittings and outlet screw fittings on the pump head with a torque wrench (see „8.4 Checking the fittings“, p. 51). ■ Clean the check valves. ■ Exchange the check valves. ■ Exchange the pump head. ■ Inform Technical Support.
Pump head leaks.	<ul style="list-style-type: none"> ■ Inspect the inlet and outlet screw fittings of the pump head. ■ If the seals are defective, eluent enters the piston backflushing; inform the Technical Support. ■ Exchange the pump head.
Flow rate is not correct.	<p>Check the following options:</p> <ul style="list-style-type: none"> ■ Check the data for the solvent compressibility. ■ Clean the check valves. ■ Exchange the check valves.
System failure	Switch off the device to reset the device's data storage and restart it afterwards.

7.3 System messages

If other system messages are displayed besides those listed below, please turn the device off and then on. Inform the Technical Support in case the system message repeats.

The system messages are in alphabetical order:

System message		
A	"A line with this time already exists: edit the time please"	Correct the time entry.
C	"Cannot delete active program/link"	Pause the program/link. Only then can the link and, subsequently, the program used in the link be deleted.
	"Cannot edit program from the running link"	Pause the link. Afterwards, the program can be changed.
	"Cannot initialize LAN"	Check cables and connections in local area network.
	"Cannot operate with an empty link"	Create a link.
	"Cannot purge during the run"	End method and start purging.
	"Cannot read data from FRAM"	Switch the device off and on. Inform the Technical Support in case the system message repeats.
	"Cannot start time table"	Check the data on the device's display or in the opened program.
	"Cannot use non-existing component"	Check if the channels to be mixed are set correctly in the <i>SETUP</i> section of the device or in the <i>INSTRUMENT SETUP</i> of the chromatography software.
	"Cannot write data on FRAM"	Switch the device off and on. Inform the Technical Support in case the system message repeats itself.
	"Component settings not compatible with gradient setup"	Change the <i>SETUP</i> settings or change the gradient in the program or in <i>SETUP</i> .
E	"Error input activated"	Eliminate the short circuit connected to 'Error In'.
F	"Flow max in the program is not compatible with the current pump head"	When entering the flow, note the maximum flow of the pump head and only enter values inside this range.

System message		
G	"GUI communication failed"	Switch the device off and on. Inform the Technical Support in case the system message repeats itself.
H	"HPG B component not present"	Switch the device off and on. Inform the Technical Support in case the system message repeats itself.
	"HPG B: Command timeout"	Switch the device off and on. Inform the Technical Support in case the system message repeats itself.
	"HPG B: incompatible pump head type"	Switch the device off and on. Inform the Technical Support in case the system message repeats itself.
	"HPG B: Service active"	Switch the device off and on. Inform the Technical Support in case the system message repeats itself.
I	"Instrument remote controlled"	This entry is not executable. Quit software.
	"Invalid index in time table"	Change the entry in the program line.
	"Invalid line number"	Change the entry in the program line.
	"Invalid link"	Create a link or use an existing link.
L	"Leak sensor not present"	Switch the device off and then on. If the leak sensor cannot be found, contact the Technical Support.
	"Leak was detected"	Switch off the device. Remove the leak and start the device afterwards.
	"Line in time table is empty"	Edit the program line.
	"Link is running"	Wait until the link has been completed, then change the link or delete it.
M	"Maximum pressure: System stopped"	Check whether the connected capillary and connectors are clogged. Adjust the maximum pressure limit. Restart the system.
	"Minimum pressure: System stopped"	Increase the pressure or adjust the lower pressure limit. Restart the system.

System message	
	<p>"Motor failure: max current"</p> <p>Switch the device off and on. Inform the Technical Support in case the system message repeats itself.</p>
	<p>"Motor failure: position error"</p> <p>Switch the device off and on. Inform the Technical Support in case the system message repeats itself.</p>
	<p>"Motor failure"</p> <p>Switch the device off and on. Inform the Technical Support in case the system message repeats itself.</p>
N	<p>"No link available. Pls edit link first"</p> <p>Create a link and edit it.</p>
	<p>"No link available"</p> <p>Create a link and edit it.</p>
	<p>"No valid pump head type detected; 50 ml pump head is set."</p> <p>Switch the device off and on.</p> <p>Check whether a pump head with RFID recognition has been installed.</p> <p>Repeat the automatic configuration step in the chromatography software.</p> <p>Remove pump head, clean it and install it again.</p>
	<p>"Non-existing component is set to non-0 value"</p> <p>Switch on the channel or edit the data using the chromatography software.</p>
	<p>"Not enough space to store link"</p> <p>Check the pump.</p> <p>Check the number of program lines - a maximum of 100 program lines are possible.</p>
	<p>"Not enough space to store program"</p> <p>Check the pump.</p> <p>Check the number of program lines - a maximum of 100 program lines are possible.</p>
	<p>"Not in HPG mode"</p> <p>Select HPG mode.</p>
P	<p>"Pressure max in the program is not compatible with the current pump head"</p> <p>Note the maximum pressure of the pump head.</p>
	<p>"Program does not exist, please edit the program number"</p> <p>Create and edit a program.</p>
	<p>"Program is running"</p> <p>Quit program or wait until program has been completed.</p>

System message	
"Pump head type: head data uninitialized"	<p>Switch the device off and on.</p> <p>Check whether a pump head with RFID recognition has been installed.</p> <p>Repeat the automatic configuration step in the chromatography software.</p> <p>Remove pump head, clean it and install it again.</p>
"Pump head type: read failed"	<p>Switch the device off and on.</p> <p>Repeat the automatic configuration step in the chromatography software.</p> <p>Remove pump head, clean it and install it again.</p> <p>Inform the Technical Support in case the system message repeats.</p>
"Pump head type: RFID hardware not present or failed"	Pump head without RFID detection: If necessary, replace pump head.
"Pump head type: write failed"	<p>Switch the device off and on.</p> <p>Repeat the automatic configuration step in the chromatography software.</p> <p>Remove pump head, clean it and install it again.</p> <p>Inform the Technical Support in case the system message repeats.</p>
S "SetPoint in the program is not compatible with the current PH PMax"	Note the maximum pressure of the pump head.
T "This link is used in WAKEUP"	First quit or delete wakeup program (wu = Wake Up), then edit or delete link.
"This program is used in a link"	First pause or delete the link, then edit or delete data by means of the chromatography software.
"This program is used in WAKEUP"	First quit or delete wakeup program (wu = Wake Up), then edit or delete data by means of the chromatography software.
"Too many lines in program"	Check the number of program lines. A maximum of 100 program lines are possible.
U "Unable to attain min. flow setpoint"	Confirm, pump continues running.

System message	
"Unable to attain pressure setpoint"	<p>The entered pressure cannot be achieved with the maximum flow set in the Constant Pressure mode.</p> <p>Check for leaks.</p> <p>Increase the upper flow level.</p> <p>Reduce the working pressure.</p>
"Unknown pump head type"	<p>Check the pump head.</p> <p>Check whether a pump head with RFID recognition has been installed.</p> <p>Inform the Technical Support in case the system message repeats.</p>
W	<p>"Wake up time already passed"</p> <p>Correct the entry for date or otherwise time.</p>

8. Maintenance and care

Maintenance of a HPLC instrument is critical to the success of analyses and the reproducibility of results. If you require a maintenance task which is not described here, contact your distributor or the Customer Support.

8.1 Maintenance contract

The following maintenance work on the device may only be performed by KNAUER or a company authorized by KNAUER and is covered by a separate maintenance contract:

- Opening the device or removing housing parts

NOTICE

Electronic defect

Performing maintenance tasks on a switched on device can cause damage to the device.

→ Switch off the device.

→ Pull the power plug.

Users may perform the following maintenance tasks themselves:

- Replacing the pump head
- Replacing the check valves of the pump head
- Replacing the inline filter of the pressure sensor
- Replacing the mixer

8.2 Maintenance intervals

Operating hours

Mobile Control and the different software products (e.g. ClarityChrom® or OpenLAB®) enable you to display or read out the operating time of the pump. You find a detailed description on how to display or read out GLP data in the respective instructions.

Operating hours	Measures
1 000	<ul style="list-style-type: none"> ■ Check the torque of the screw fittings. ■ Clean the pistons of the pump. ■ Check the check valves of the pump head.
5 000	<ul style="list-style-type: none"> ■ Replace all seals. ■ Clean the check valves of the pump head.
10 000	<ul style="list-style-type: none"> ■ Replace the spare parts in the pump head. ■ Replace the check valves of the pump head.

8.3 Cleaning and caring for the device

All smooth surfaces of the device can be cleaned with a mild, commercially available cleaning solution, or with isopropanol.

Display Touchscreens can be cleaned with isopropanol and wiped dry with a soft, lint-free cloth.

NOTICE

Device defect

Intruding liquids can cause damage to the device.

- Place solvent bottles next to the device or in a solvent tray.
- Moisten the cleaning cloth only slightly.

8.4 Checking the fittings

Check if all fittings are tight. In case you find fittings that are not tight, tighten them up. Note the torque applicable for each fitting in order to not damage any components.

Material & size	Pump head inlet	Pump head outlet
Stainless steel 5 ml	7.5 Nm	10 Nm
Stainless steel 10 ml, 50 ml	7.5 Nm	7.5 Nm

Inline filter fittings	Torque
Stainless steel fittings	7.5 Nm
PEEK fittings	3.5 Nm

Capillary screw fittings	Torque
Stainless steel fittings	5 Nm
PEEK fittings	1 Nm

8.5 Flushing the pump

Generally, the pump and all its components (valves, degasser) should be flushed after each operation. Also, flush the pump to clean the tubing before changing the solvent and to remove air bubbles in the capillary and tubing. If buffer solution has been employed, note that the buffer solution and the flushing solution are compatible.

- When buffers have been used, flush with water.
- When aggressive solvents have been used, flush with isopropanol.



Note: For applications with normal phase, only use isopropanol as flushing solution.

- Materials**
- Flushing solution
 - Silicone tubing

Procedure**Process**

1. Immerse the solvent tubing into the flushing solution.
2. Plug a silicone tube onto the venting nozzle ② of the pressure sensor.
3. Open the venting screw ①.
4. Start the pump at a medium flow rate.

Figure

Fig. 32: Pressure sensor

Next step Bring the pump into operation again.

8.6 Maintaining the pump head

8.6.1 Dismounting the pump head

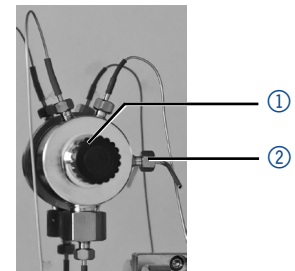
Prerequisites

- The pump head has been purged.

Tools

- Allen wrench 3 mm
- Open-end wrench, size 1/4"
- Open-end wrench, size 13

⚠ WARNING

Chemical burns

Skin damage from aggressive or toxic eluents.

- Wear protective gloves.
- Flush the pump head before changing.

NOTICE

Component defect

Possible damage to the pump piston by tilting the pump head.

- Tighten diagonally opposite fastening screws evenly one turn at a time.
- Also loosen the fastening screws evenly.

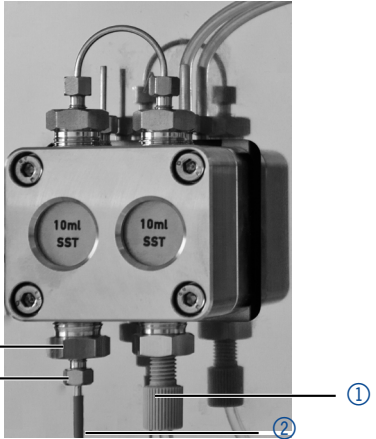
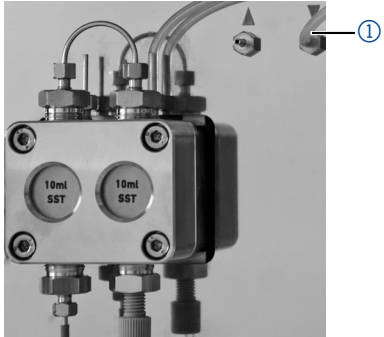
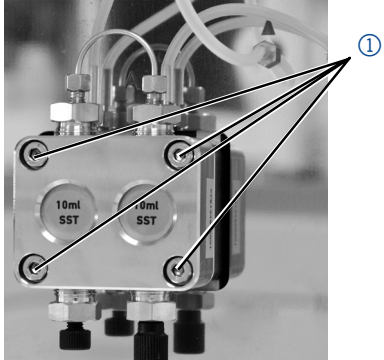
Procedure	Process	Figure
	<ol style="list-style-type: none"> 1. Loosen the finger-tight fitting ①. 2. Remove the tubing ②. 3. Fixate the outlet fitting ④ with an open-end wrench (size 13). 4. Loosen the fitting ③ with an open-end wrench (size 1/4"). 5. Remove the capillary. 	 <p>Fig. 33: Removing fittings and tubings</p>
	<ol style="list-style-type: none"> 6. Disconnect the tubing of the piston backflushing ① from the flush pump and the pump head. 	 <p>Fig. 34: Removing tubing of piston backflushing</p>
	<ol style="list-style-type: none"> 7. Using the Allen wrench, unscrew the 4 screws ① subsequently by one turn. 8. Fixate the pump head with your hand and remove the screws. 9. Lift off the pump head. 	 <p>Fig. 35: Removing screws</p>

Next steps Maintain the check valves (see next section) or install a new pump head.

8.6.2 Check valves

Clogged check valves do not open and close properly. They cause pressure fluctuations and irregular flow. If it is impossible to clean the check valves, replace the whole unit.

- Procedure**
- Removing the check valves
 - Cleaning the check valves
 - Installing the check valves

8.6.2.1 Removing the check valves

The pump head is equipped with two check valves.

- Prerequisites**
- The pump head has been purged.
 - The capillaries and tubings have been removed.
 - The pump head has been removed.
- Tool**
- Open-end wrench, size 13

Procedure

Process

1. Unscrew and remove the capillary connector ①.
2. Loosen the outlet fitting ② with the open-end wrench.
3. Remove the first check valve.
4. Loosen the inlet fitting ③ with the open-end wrench.
5. Remove the second check valve.

Figure

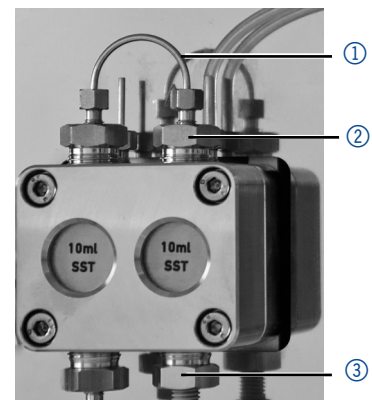

Fig. 36: Check valve in pump head

- Next steps** Clean the check valves.

8.6.2.2 Cleaning the check valve

The check valves cannot be disassembled for cleaning but they are cleaned as a unit.

- Prerequisite**
- Both check valves have been removed.

Procedure

Process

1. Place each check valve into a beaker with solvent, e.g. isopropanol.
2. Put the beaker with the check valve in an ultrasonic bath for at least 10 minutes.
3. Let the check valves dry afterwards.

- Next step** Insert both cleaned check valves.

8.6.2.3 Installing the check valve

NOTICE

Component defect

Damaging the threads of components caused by overtightened fittings. Pay attention to the torque values.

- Use 7.5 Nm for the bushing on stainless steel pump head.
- Use 3.5 Nm for bushing on ceramic pump head.

Reversed phase Insert the check valves in the direction of the flow. The notch of the check valve points downward.

Normal phase Insert the check valves in the direction of the flow. The arrow on the check valve points upward.

Prerequisite ■ The check valves have dried.

Procedure

Process

1. Insert the check valves ① so that the notch of the check valve ② points downward (Fig. 37).
If the pump head is equipped with the check valve type A068411 (Fig. 38), the arrow on the cartridge must point upward.
2. Manually screw in inlet and outlet fittings and tighten them with a torque wrench and the respective torque.

Figure

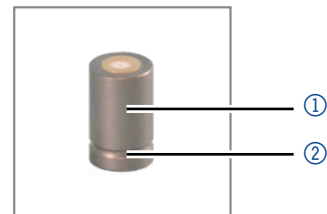

Fig. 37: Check valve (A06841)



Fig. 38: Check valve (A068411)

Next step Re-install the pump head.

8.7 Inline filter on the pressure sensor

Clogged inline filters inside of the pressure sensor can cause pressure fluctuations and irregular flow. Inline filters are not cleaned but exchanged as an assembly.



Note: It is recommended to replace the filter cartridge after 5 000 working hours.

- Procedure**
1. Remove the capillary below the inline filter of the pressure sensor.
 2. Loosen the fitting of the inline filter and remove manually.
 3. Insert a new inline filter cartridge.

8.7.1 Removing the inline filter

Below the pressure sensor, you find the fitting of the inline filter.

- Prerequisite**
- The pump has been rinsed.
- Tools**
- Open-end wrench, size 1/4"
 - Open-end wrench, size 13

Procedure

Process

1. Fixate the outlet fitting ② with an open-end wrench (size 13).
2. Loosen the fitting ③ below the inline filter ② of the pressure sensor ① with the open-end wrench.

Figure

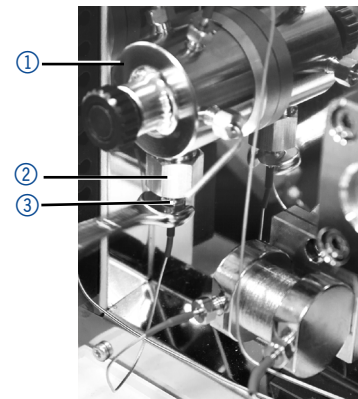

Fig. 39: Loosen the capillary

3. Loosen the fitting of the inline filter ① with the open-end wrench (size 13) and remove manually.
4. Remove clogged inline filter cartridge.

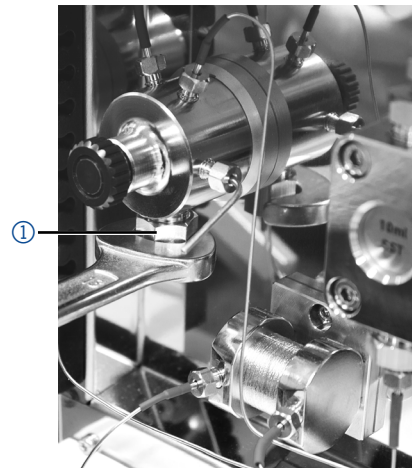

Fig. 40: Loosen the screw fitting of the inline filter cartridge

Next step Insert the new inline filter cartridge.

8.7.2 Inserting the new inline filter cartridge

NOTICE

Component defect

Damage to components due to excessive tightening possible. Observe the torque of the screw connection.

- Use 5 Nm torque for stainless steel fittings.
- Use 1 Nm torque for PEEK fittings.

The flow direction is designated on inline filter cartridges. The inline filter and fitting are inserted into the pressure sensor in such a way that the designating notch always points upwards.

The inline filter with article number A9661 (titanium, 2 µm, 60 µl volume, for bio-inert pump variants) does not have a notch. For this inline filter, the titanium filter disc on the bottom of the cartridge is clearly visible (see Fig. 42). The side with the filter disc represents the output.

Tool ■ Torque wrench

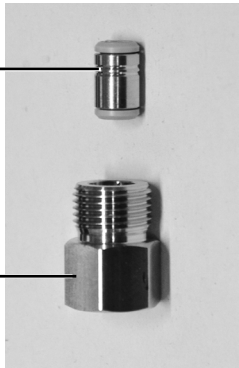
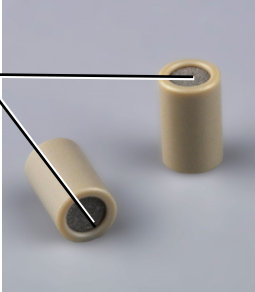
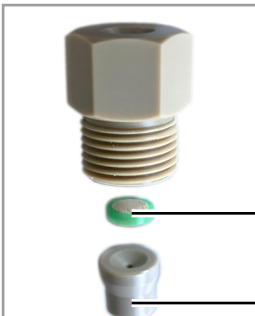
Procedure	Process	Figure
	<ol style="list-style-type: none"> <li data-bbox="528 562 965 770">1. Insert the inline filter cartridge with the designating notch pointing upwards ① (A96601) or titanium filter disc facing downwards ③ (A9661) into the fitting ②. <p data-bbox="568 801 965 1010">Note: For devices with serial number FXX2109XXXXX or higher (AZURA® Pump P 6.1L Ceramic), the filter (A9663) consists of two parts: filter disk ④ and pressure piece ⑤.</p> <ol style="list-style-type: none"> <li data-bbox="528 1041 965 1137">2. Manually, screw the fitting with the inline filter cartridge in the pressure sensor. <li data-bbox="528 1146 965 1243">3. Using the torque wrench, tighten the fittings with the appropriate torque. 	 <p data-bbox="1002 974 1481 1077">Fig. 41: Inset filter cartridge A96601 (for stainless steel pump)</p>  <p data-bbox="1002 1422 1481 1489">Fig. 42: Inset filter A9661 (with titanium filter disk)</p>  <p data-bbox="1002 1870 1481 1937">Fig. 43: Inset filter cartridge A9663 (for ceramic pump)</p>
Next steps	Reinstall the capillary at the pressure sensor below the fitting of the inline filter.	

8.8 Replacing the mixer

A clogged mixer can cause pressure fluctuations and irregular flow. The mixer is replaced completely as an assembly.

- Prerequisites**
- The mixer has been rinsed with isopropanol.
 - The sealing plugs are on site.

- Tools**
- Open-end wrench, size 1/4"
 - Allen wrench, size 2 mm

Process

1. Remove capillary ① at the inlet and outlet of the mixer by hand or with the open-end wrench.
1. Seal the inlet and the outlet with the sealing plug.
2. Remove the screws ② with the Allen wrench.
3. Detach the mixer and set aside.
4. Install the new mixer.
5. Manually, screw the fittings of the capillary in the mixer.
6. Tighten with a torque wrench using the appropriate torque.

Figure

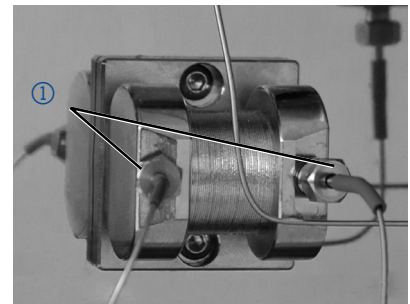

Fig. 44: HPLC mixer



Fig. 45: Bio mixer

Next step Bring the device into operation again.

8.9 Removing a leakage

- Prerequisites**
- The device is switched off.

- Material**
- Cloth

Procedure

Process

1. Remove the leakage.
2. Dry the leakage tray with the cloth.
3. Confirm the error message via the chromatography software.

Next step Put the device back into operation.

9. Transport and storage

Regarding the following information, carefully prepare the device for transport or storage.

9.1 Putting the pump out of operation

Prerequisites The device is switched off.

Procedure

Process

1. Pull the power plug out of the socket and then out of the device.
2. Pack the power cable together with the device.

Next steps

- Disconnect all electrical connections.
- Remove the accessories and pack the device for transport or storage.

9.2 Packing the device

- Original packaging: Ideally you should use the original transport packaging.
- Lifting: Grab the device around the center of both sides and lift it into the packaging. Do not hold onto front cover or leak tray, as these parts are loosely attached to the device.

9.3 Transporting the device

Carefully prepare the device for transport or storage. If you want to return your device to KNAUER for repairs, enclose the [Service Request Form](#) which can be downloaded from our website.

Device data For a secure transport, note the weight and dimensions of the device (see „11. Technical data“ on page 62).

CAUTION

Bruising danger

Damage to the device by carrying or lifting it on protruding housing parts. The device may fall and thus cause injuries.

→ Lift the device only centrally on the side of the housing.

Lifting

Clasp the device at its side panels and lift it out of the packaging. Do not hold onto front cover or leak tray.

9.4 Storing

9.4.1 Storing the device

If the pump is not used for several weeks, solvent residues cause damage.

Therefore, make sure that all tubes, capillaries and pump heads (if they are to remain on the pump during storage) have been drained or filled with flushing solution (e.g. isopropanol) before storage. To avoid algae

formation, do not use pure water. Close all inlets and outlets with blind screwings.

- Prerequisites**
- The pump has been flushed.
 - The pump has been switched off and disconnected from the power supply.

- Tool**
- Open-end wrench, size 10

Procedure

Process

1. Remove the solvent tubing and seal all open connectors with cap fittings.
2. Remove the pump from the HPLC system and seal the open connector of the pressure sensor (isocratic version) or the mixer (binary or quaternary version) with cap fittings.

Storage conditions The device can be stored under the ambient conditions described in chapter „11. Technical data“ on page 62.

9.4.2 Storing the pump head

NOTICE

Device defect

Residuals chemicals can damage the pump head if they are not being removed before storage.

- ➔ For reuse, flush the pump head and fill it with isopropanol.
- ➔ Before storage, seal the inlets and outlets with cap fittings.

If you want to store pump heads separately, proceed as follows:

Prerequisite The pump head has been dismantled (see chap. „8.6.1 Dismounting the pump head“, p. 52).

- Materials**
- Syringe
 - Flushing solution

Procedure

Process

1. Fill the flushing solution into a syringe and inject into the capillary at the pump head inlet. Leave it for 5 minutes.
2. Flush with suitable purging solution.
3. Fill the pump head with isopropanol.
4. Seal the inlets and outlets with cap fittings.

Storage conditions The pump head can be stored under the ambient conditions described in chapter „11. Technical data“ on page 62.

10. Disposal

Hand in old devices or disassembled old components at a certified waste facility, where they will be disposed of properly.

10.1 AVV-Marking Germany

According to the German "Abfallverzeichnisverordnung" (AVV) (January, 2001), old devices manufactured by KNAUER are marked as waste electrical and electronic equipment: 160214.

10.2 WEEE registration number

KNAUER as a company is registered by the WEEE number DE 34642789 in the German "Elektroaltgeräteregister" (EAR). The number classifies to category 8 and 9, which, among others, comprises laboratory equipment.

All distributors and importers are responsible for the disposal of old devices, as defined by the WEEE directive. End-users can send their old devices manufactured by KNAUER back to the distributor, the importer, or the company free of charge, but would be charged for the disposal.

10.3 Eluents and other operating materials

All eluents and other operating materials must be collected separately and disposed of properly.

All wetter components of a device, e. g. flow cells of detectors or pump heads and pressure sensors for pumps, have to be flushed with isopropanol first and water afterwards before being maintained, disassembled or disposed.

11. Technical data

11.1 Main features

Solvent conveyance	Variants	<ul style="list-style-type: none"> ■ Isocratic HPLC pump ■ Quaternary low-pressure gradient pump (LPG pump) ■ Binary high-pressure gradient pump (HPG pump)
	Delivery system	Dual-piston pump
	Pulsation compensation	Active pressure and pulsation compensation
	Pulsation	< 2 % Amplitude (typically: < 1.3 %) or < 3 bar (0,3 MPa), whatever is greater, at 1 ml/min ethanol, at all pressures > 10 bar (1 MPa, 147 psi)
	Flow rate range	<ul style="list-style-type: none"> ■ 0.001 - 10 ml/min ■ 0.1 - 8 ml/min (recommended) ■ 0.01 - 50 ml/min ■ 0.1 - 40 ml/min (recommended)
	Flow rate increment	0.001 ml/min
	Flow rate accuracy	± 0.25 % (measured at 5 - 80 % of flow range, using ethanol)
	Flow rate precision	≤ 0.04 % RSD or 0.008 min SD (whichever is greater) (based on the retention time at constant room temperature)
	Flushing piston seal	Standard
	System protection	Soft start, Pmin und Pmax are programmable
Degasser module	Wetted materials	Stainless steel, Ultra-high molecular weight Polyethylene (UHMW PE), FKM, PEEK, sapphire, ruby, aluminum oxide (Al ₂ O ₃)
	Degasser channels	2/4 channels, Teflon® AF
	Degasser max. flow rate	10 ml/min
	Degasser method	Gas permeation using Teflon® AF amorphous fluoropolymer membrane
	Degasser efficiency	< 0.5 ppm dissolved O ₂ at 1 ml/min
	Degassing chamber volume	480 µl volume per channel

Eluents	Limitations: Concentrated acids (1 mol/l or greater), hexafluoroisopropanol, sodium azide, fluorinated and perfluorinated eluents and freons
Wetted materials	PEEK, Tefzel®, Teflon® AF
Vacuum pump	Low hysteresis

11.2 Communication

Interfaces	<ul style="list-style-type: none"> ■ LAN ■ Pin header connectors (Analog IN, Start IN, Error IN)
Control	<ul style="list-style-type: none"> ■ LAN ■ Analog and event control ■ Mobile Control
Analog input	0-10 V
Analog control input	Flow rate
Level / event outputs	8 event outputs (TTL, OC, Relais) and 24 V
Programming	19 programs, 9 program links, 1 WAKE UP program
GLP	RFID pump head detection, detailed report
Display	3 LEDs
Leak sensor	Yes
Protection type	IP-20

11.3 General

Permitted operating environment	Power supply	<ul style="list-style-type: none"> ■ Power input: 100-240 V ■ Output: 50-60 Hz ■ Maximum power consumption: 100 Watt
	Dimensions (W × H × D)	361 mm x 208.2 mm x 523 mm
	Weight	(see „11.4 Device variants“, p. 64).
	Leak sensor	Yes
	Area of use	For indoor use only
	Line voltage fluctuations do not exceed ± 10 % of normal voltage.	

Overvoltage category II:	Energy consumers are supplied by a fixed device.
Permitted pollution degree	2
Temperature range	4-40 °C (39.2-104 °F)
Air humidity	below 90 %, non-condensing
Operating height	max. 2000 meters above sea level

11.4 Device variants

11.4.1 Isocratic

Setup	Pump type	Isocratic analytical HPLC pump
	Pump head versions	<ul style="list-style-type: none"> ■ 5 ml/min stainless steel ■ 10 ml/min stainless steel ■ 10 ml/min stainless steel, for normal phase applications ■ 50 ml/min stainless steel ■ 10 ml/min ceramic ■ 50 ml/min ceramic ■ 50 ml/min stainless steel, for normal phase applications
	Delay volume	60 µl (at 10 ml/min)
Weight	Weight	11.5 kg

11.4.2 Binary

Setup	Pump type	Binary analytical HPLC pump with degasser
	Pump head versions	<ul style="list-style-type: none"> ■ 5 ml/min stainless steel ■ 10 ml/min stainless steel ■ 10 ml/min ceramic ■ 10 ml/min for stainless steel for normal phase applications
	Degasser	2/4 channels
	Solvent selection valve	2 x 2 channels
Weight	Weight	14.1 kg
Gradient formation	Gradient type	High-pressure gradient

	Gradient range	0 - 100 % 5 - 95 % (recommended)
	Minimum increment	0.1 %
	Gradient precision	± 0.3 % (measured at 1 ml/min, 150 bar, tracer: ethanol/caffeine) ± 1 % (5 - 95 %, measured at 0.1 - 10 ml/min, tracer: water/caffeine)
	Gradient repeat accuracy	< 0.1 % RSD (measured at 1 ml/min, 0.3 % RSD overall, based on retention time at constant room temperature)
Mixer	Mixing volume	50, 100, 200 µl; 250 µl (metal-free)
	Delay volume	110 µl (dependent on mixer), 410 µl (metal-free)

11.4.3 Quaternary

Setup	Pump type	Quaternary analytical HPLC pump with degasser
	Pump head versions	<ul style="list-style-type: none"> ■ 5 ml/min stainless steel ■ 10 ml/min stainless steel ■ 10 ml/min ceramic
	degasser	4 channels, Teflon® AF
	Special feature	Automatic adaption of LPG cycle time
Weight	weight	12.7 kg
Gradient formation	Gradient type	Low-pressure gradient
	Gradient range	<ul style="list-style-type: none"> ■ 0 - 100 % ■ 1 - 99 % (recommended)
	Minimum increment	0.1 %
	Gradient precision	<ul style="list-style-type: none"> ■ ± 0,3 % (measured at 1 ml/min, 150 bar, tracer: ethanol/caffeine) ■ ± 2 % (1 - 99 %, measured at 5 - 50 % of the flow range, tracer: water/caffeine)
	Gradient repeat accuracy	< 0.1 % RSD (measured at 1 ml/min, 0.5 % RSD overall, based on retention time at constant room temperature)
Mixer	Mixing volume	50, 100, 200 µl; 250 µl (metal-free)
	Delay volume	210 µl (dependent of mixer), 410 µl (metal-free)

11.5 Pump heads

Flow rate range	5 ml pump head	<ul style="list-style-type: none"> ■ 0.001 - 5 ml/min ■ 0.02 - 5 ml/min (recommended)
	10 ml pump head	<ul style="list-style-type: none"> ■ 0.001 - 10 ml/min ■ 0.1 - 8 ml/min (recommended)
	50 ml pump head	<ul style="list-style-type: none"> ■ 0.01 - 50 ml/min ■ 0.1 - 40 ml/min (recommended)
Maximum pressure	5 ml pump head	<ul style="list-style-type: none"> ■ 1000 bar (100 MPa, 14504 psi) up to 2 ml/min ■ 700 bar (70 MPa, 10150 psi)
	10 ml pump head	<p>Stainless steel</p> <ul style="list-style-type: none"> ■ 862 bar / 86.2 MPa / 12500 psi up to 2 ml/min ■ Linear reduction: 862 - 400 bar from 2 - 5 ml/min ■ 400 bar / 40 MPa / 5800 psi up to 10 ml/min <p>Ceramic</p> <ul style="list-style-type: none"> ■ 400 bar / 40 MPa / 5800 psi up to 10 ml/min
	50 ml pump head	200 bar (20 MPa, 2900 psi)

12. Chemical compatibility of wetted materials



Note: The user takes the responsibility for using the fluids and chemicals in an appropriate and safe way. If there is any doubt, contact the Technical Support of the manufacturer.

12.1 General

The device is very resistant against a variety of commonly used eluents. However, make sure that no eluents or water come in contact with the device or enter into the device. Some organic solvents (such as chlorinated hydrocarbons, ether) may cause coating damage or loosen glued components by improper handling. Even small quantities of other substances, such as additives, modifiers, or salts can influence the durability of the materials. Exposure time and concentration have a high impact on the resistance.

The following list contains information about the chemical compatibility of all wetted materials which are used in devices made by KNAUER. The data bases on a literature research on the manufacturer specifications of the materials. The wetted materials of this device are listed in the chapter "Technical data".

All resistances mentioned here are for use at temperatures up to 40 °C, unless stated otherwise. Please note that higher temperatures can significantly affect the stability of different materials.

12.2 Plastics

Polyetheretherketone (PEEK)

PEEK is a durable and resistant plastic and, next to stainless steel, the standard material in HPLC. It can be used at temperatures up to 100 °C and is highly chemical resistant against almost all commonly used solvents in a pH range of 1-12,5. PEEK is potentially moderate resistant against oxidizing and reducing solvents.

Therefore, following solvents should not be used: Concentrated and oxidizing acids (such as nitric acid solution, sulfuric acid), halogenated acids (such as hydrofluoric acid, hydrobromic acid) and gaseous halogens. Hydrochloric acid is approved for most applications.

In addition, following solvents can have a swelling effect and may have an impact on the functionality of the built-in components: Methylene chloride, THF and DMSO in any concentration such as acetonitrile in higher concentrations.

Polyethylene terephthalate (PET, outdated PETP)

PET is a thermoplastic and semi-crystalline material with high wear resistance. It is resistant against diluted acids, aliphatic and aromatic hydrocarbons, oils, fats and alcohols, but not against halogenated hydrocarbons and ketones. Since PET belongs chemically to esters, it is not compatible with inorganic acids, hot water and alkalis. Maximum operating Temperature: up to 120 °C.

Polyimide (Vespel®)

This material is wear-resistant and permanent resilient thermally (up to 200 °C) as well as mechanically. It is chemically broadly inert (pH range 1-10) and is especially resistant against acidic to neutral and organic solvents, but vulnerable to pH strong chemical or oxidizing environments: It is incompatible with concentrated mineral acids (such as sulfuric acid), glacial acetic acid, DMSO and THF. In addition, it will be disintegrated by nucleophilic substances like ammonia (such as ammonium salts under alkaline conditions) or acetate.

Ethylene-tetrafluorethylene copolymer (ETFC, Tefzel®)

This fluorinated polymer is highly resistant against neutral and alkaline solvents. Some chlorinated chemicals in connection with this material should be handled with care. Maximum operating Temperature is 80 °C.

Perfluorethylenpropylen-Copolymer (FEP), Perfluoralkoxy-Polymer (PFA)

These fluorinated polymers hold similar features as PTFE, but with a lower operation temperature (up to 205 °C). PFA is suitable for ultrapure applications, FEP can be used universally. They are resistant against almost all organic and inorganic chemicals, except elemental fluorine under pressure or at high temperatures and fluorine-halogen compounds.

Polyoxymethylene (POM, POM-H-TF)

POM is a semi-crystalline, high-molecular thermoplastic material which stands out due to its high stiffness, low friction value and thermic stability. It can even substitute metal in many cases. POM-H-TF is a combination of PTFE fibres and acetal resin and is softer and has better slip properties as POM. The material is resistant against diluted acids (pH > 4) as well as diluted lyes, aliphatic, aromatic and halogenated hydrocarbons, oils and alcohols. It is not compatible with concentrated acids, hydrofluoric acid and oxidizing agent. Maximum operating Temperature is 100 °C.

Polyphenylene sulfide (PPS)

PPS is a soft polymer which is known for its high break resistance and very high chemical compatibility. It can be used with most organic, pH neutral to pH high, and aqueous solvents at room temperature without concerns. However, it is not recommended for using with chlorinated, oxidizing and reducing solvents, inorganic acids or at higher temperatures. Maximum operating temperature: 50 °C.

Polytetrafluorethylene (PTFE, Teflon®)

PTFE is very soft and anti-adhesive. This material is resistant against almost all acids, lyes and solvents, except against fluid sodium and fluoride compounds. In addition, it is temperature-resistant from -200 °C to +260 °C.

Systec AF™

This amorphous perfluorinated copolymer is inert against all commonly used solvents. However, it is soluble in perfluorinated solvents like Fluorinert® FC-75 and FC-40, and Fomblin perfluor-polyether solvents from Ausimont. In addition, it is affected by Freon® solvents.

Polychlorotrifluoroethylene (PCTFE, Kel-F®)

The semi-crystalline thermoplastic material is plasticizer-free and dimensionally stable, even in a wide temperature range (-240 °C to +205 °C). It is moderately resistant against ether, halogenated solvents and toluene. Halogenated solvents over +60 °C and chlorine gas should not be used.

Fluorinated rubber (FKM)

The elastomer consisting of fluorinated hydrocarbon stands out due to a high resistance against mineral oils, synthetic hydraulic fluids, fuels, aromatics, and many organic solvents and chemicals. However, it is not compatible with strong alkaline solvents (pH value >13) like ammonia, and acidic solvents (pH value <1), pyrrole and THF. Operating temperature: Between -40 °C and +200 °C.

Perfluorinated rubber (FFKM)

This perfluoro elastomer has a higher fluorine content as fluorinated rubber and is therefore chemically more resistant. It can be employed at higher temperatures (up to 275 °C). It is not compatible with Pyrrole.

12.3 Non-metals

Diamond-like carbon (DLC)

This material is characterized by a high hardness, a low coefficient of friction and thus low wear. In addition, it is highly biocompatible. DLC is inert against all acids, alkalis and solvents commonly used in HPLC.

Ceramic

Ceramic is resistant against corrosion and wear and is fully biocompatible. An incompatibility against acids, alkalis and solvents commonly used in HPLC is not known.

Alumina (Al₂O₃)

Due to their high resistance to wear and corrosion, alumina ceramic is used as a coating for mechanically stressed surfaces. It is a biocompatible material with low thermal conductivity and low thermal expansion.

Zirconium oxide (ZrO₂)

Zirconia ceramics are characterized by their high mechanical resistance, which makes them particularly resistant to wear and corrosion. It is also biocompatible, has low thermal conductivity and is resistant to high pressures.

Sapphire

Synthetic sapphire is virtually pure monocrystalline alumina. It is biocompatible and very resistant to corrosion and wear. The material is characterized by a high hardness and a high thermal conductivity.

Ruby

Synthetic ruby is monocrystalline alumina and gets its red color by the addition of some chromium oxide. It is biocompatible and very resistant to corrosion and wear. The material is characterized by a high hardness and a high thermal conductivity.

Mineral wool

This insulating material consists of glass or stone wool fibres and isolates in high oxidizing conditions and at high temperatures. Mineral wool is valid as commonly inert against organic solvents and acids.

Glass, glass fibre, quartz, quartz glass

These mineral materials are resistant against corrosion and wear and are mostly chemical inert. They are compatible with oils, fats and solvents and show a high resistance against acids and lyes up to pH values of 3-9. Concentrated acids (especially hydrofluoric acid) may embrittle and corrode the minerals. Lyes may ablate the surfaces slowly.

12.4 Metals

Stainless steel

Stainless steel is, apart from PEEK, the standard material in HPLC. Steels with WNr. 1.4404 (316L) are used, or with a mixture of higher compatibility.

They are inert against almost all solvents. Exceptions are biological applications which are metal ion sensitive, and applications with extreme corrosive conditions. These steels, in comparison to commonly used steels, are increasingly resistant against hydrochloric acid, cyanides and other halogen acids, chlorides and chlorinated solvents.

The use in ion chromatography is not recommended. In case of electrochemical applications, a passivation must be executed first.

Hastelloy®-C

This nickel-chrome-molybdenum alloy is extremely resistant to corrosion, especially against oxidizing, reducing and mixed solvents, even at high temperatures. This alloy may be used in combination with chlor, formic acid, acetic acid and saline solutions.

Titanium, titanium alloy (TiA16V4)

Titanium has a low weight and a high hardness and stability. It stands out due to its very high chemical compatibility and biocompatibility. Titan is applied when neither stainless steel nor PEEK are usable.

13. Repeat orders

This list for reorders is valid for the time the document has been published. Deviations afterwards are possible.

For reorders of spare parts use the enclosed packing list. Contact the Technical Support in case there are any questions on spare parts or accessories.

Further information Further information on spare parts and accessories can be found online: www.knauer.net.

13.1 Devices

Name	Article no.
AZURA® Pump P 6.1L isocratic with 10 ml pump head (stainless steel)	APH30EA
AZURA® Pump P 6.1L isocratic with 10 ml NP pump head (stainless steel)	APH30ED
AZURA® Pump P 6.1L isocratic with 50 ml pump head (stainless steel) without degasser	APH30FA
AZURA® Pump P 6.1L isocratic with 50 ml pump head (stainless steel) for normal phase applications	APH30FD
AZURA® Pump P 6.1L isocratic with 10 ml pump head (stainless steel) with 2 channel degasser and SSV	APH31EA
AZURA® Pump P 6.1L LPG with 10 ml pump head (stainless steel), degasser and mixer (200 µl)	APH34EA
AZURA® Pump P 6.1L (UHPLC) LPG with 5 ml pump head (stainless steel), degasser and mixer (200 µl)	APH34GA
AZURA® Pump P 6.1L HPG with 10 ml pump head (stainless steel), degasser and mixer (100 µl)	APH35EA
AZURA® Pump P 6.1L HPG with 10 ml NP pump head (stainless steel), degasser and mixer (100 µl)	APH35ED
AZURA® Pump P 6.1L (UHPLC) HPG with 5 ml pump head (stainless steel), degasser and mixer (100 µl)	APH35GA
AZURA® Pump P 6.1L HPG without degasser with 10 ml pump head (stainless steel) and mixer (100 µl)	APH38EA
AZURA® Pump P 6.1L HPG without degasser with 10 ml NP pump head (stainless steel) and mixer (100 µl)	APH38ED
AZURA® Pump P 6.1L HPG without degasser with 50 ml pump head (stainless steel) and mixer (200 µl)	APH38FA
AZURA® Pump P 6.1L LPG without degasser with 10 ml pump head (stainless steel) and mixer (200 µl)	APH39EA
AZURA® Pump P 6.1L (metal free) with 10 ml pump head (ceramic)	APH60EB

Name	Article no.
AZURA® Pump P 6.1L (metal free) with 50 ml pump head (ceramic)	APH60FB
AZURA® Pump P 6.1L (metal free) LPG with 10 ml pump head (ceramic), degasser and mixer (250 µl)	APH64EB
AZURA® Pump P 6.1L (metal free) HPG with 10 ml pump head (ceramic), degasser and mixer (250 µl)	APH65EB
AZURA® Pump P 6.1L (metal free) HPG without degasser with 10 ml pump head (ceramic) and mixer (250 µl)	APH68EB
AZURA® Pump P 6.1L (metal free) HPG without degasser with 50 ml pump head (ceramic) and mixer (250 µl)	APH68FB
AZURA® Pump P 6.1L (metal free) LPG without degasser with 50 ml pump head (ceramic) and mixer (250 µl)	APH69EB

13.2 Accessories and spare parts

	Name	Article no.
Pump head	Pump head, 5 ml, stainless steel	AHA60
	Pump head, 10 ml, stainless steel	AHB40XA
	Pump head, 10 ml, ceramic	AHB32
	Pump head, 10 ml, ceramic for aqueous solutions	AHB32FA
	Pump head 10 ml, stainless steel for normal phase	AHB40BA
	Pump head, 50 ml, stainless steel	AHC20
	Pump head 50 ml, stainless steel for normal phase	AHC20BA
	Pump head, 50 ml, ceramic	AHC22
	Pump head, 50 ml, ceramic for aqueous solutions	AHC22FA
Check valves	Check valve unit for AZURA® 5, 10 ml pump head, ruby, sapphire	A06841
	Check valve unit for AZURA® 5, 10 ml pump head, normal phase, spring-supported, ruby, sapphire	A068411
	Check valve unit for AZURA® 50 ml pump head, ruby, sapphire	A06842
Inline filter cartridge	Filter cartridge, stainless steel, 2 µm (20 µl volume)	A96601
	Filter cartridge, titanium, 2 µm (60 µl volume)	A9661
	Filter cartridge, PEEK, 2 µm (20 µl volume, 10 ml/min max. flowrate)	A96611

	Name	Article no.
	Filter cartridge, PEEK, 2 µm (20µl volume), for AZURA® Pump P 6.1L ceramic from serial no. FXX2109XXXXX and higher	A9663
Mixer	AZURA® mixer 50 µl	AZZ00MB
	AZURA® mixer 100 µl	AZZ00MC
	AZURA® mixer 200 µl	AZZ00MD
	AZURA® mixer 250 µl, bio	AZZ10ME
Solvent tray	AZURA® solvent tray E 2.1L	AZC00
Drainage system	Corrugated hose, 16 cm, PE grey	A9846-1
	Corrugated hose, 150 cm, PE grey	A9846-3
	Funnel	P6431
	Exhaust	P6432
Capillary guide	Capillary guide top	P6424
	Capillary guide side	P6425
Mobile Control	Mobile Control license with 10" touchscreen	A9607
	Mobile Control Chrom license with 10" touchscreen	A9608
	Mobile Control license	A9610
	Mobile Control Chrom license	A9612
Accessories kit	AZURA® accessories kit	FZA02
	Accessories kit P 6.1L isocratic	FPH30
	Accessories kit P 6.1L quaternary	FPH34
	Accessories kit P 6.1L binary	FPH35
Tools	AZURA® tool kit	A1033
	Capillary cleaning kit	A0137
	Metal capillary cutter	A0681
Product riser	AZURA® product riser (28 mm)	A9860
Power cable	USA	M1651
	UK	M1278
	Switzerland	M1597
	Europe	M1642

	Name	Article no.
Documents	Instructions AZURA® Pump P 6.1L	V6890
	Installation Qualification Document	VIQ-INST
	Operation Qualification Document	VOQ-PUMPS

Index

- A**
 - ambient conditions 15
 - ambient temperature 15
 - AVV-marking 61
- B**
 - Binary pump 10, 20
 - Binary pump - front view 10
- C**
 - Capillaries and fittings
 - Connecting 17
 - Pre-installed capillaries 17
 - Check valves
 - Cleaning 54
 - Removing 54
 - Chemical compatibility of wetted materials 67
 - Company network 28
 - Connector
 - Connecting the pin header 37
 - Connector assignment 34
 - Events connector 35
 - Remote connector 34
- D**
 - Disposal 61
- F**
 - Firmware Wizard:
 - Setting IP addresses 32-33
 - Functionality tests 42
 - Installation Qualification (IQ) 42
 - Operation Qualification (OQ) 42
- I**
 - initial startup 15
 - Inline filter 55
 - Inserting 56
 - Removing 55
 - Installation 15
 - Installation Qualification (IQ) 42
 - IP address
 - setting 29-33
 - Isocratic pump 10, 18
 - Isocratic pump - front view 10
- L**
 - LAN
 - connect 26-29
 - leak
 - management 17
 - Leakage
 - Removing 58
 - Leak management
 - Connecting 25
 - LED panel 12
- M**
 - Maintenance and care 50
 - Cleaning 51
 - Intervals 50
 - Maintenance contract 50
 - Mixer
 - Replacing 57
 - Mobile Control
 - Setting IP addresses 29-31
- O**
 - Old devices 61
 - Operation Qualification (OQ) 42
 - operation site 15
 - Original packaging 59
- P**
 - Piston backflushing
 - Connecting 23
 - power supply 16
 - Power supply 16
 - Pump
 - Device variants 64
 - Disposal 61
 - Initial operation 39
 - Main features 62
 - Maintenance and care 50
 - Purging 39
 - Software control 41
 - Switch-on 40

Transport and storage 59

Pump head

Connecting the pump head to the solvent 19

Dismounting 52

Pump head running-in 39

Q

Quaternary pump 11, 22

Quaternary pump - front view 11

R

Repeat orders 71

Router 28

S

Solvent

Disposal 61

Space requirement 16

standby 12

storage 59

T

Technical data 62

transport 59

Troubleshooting 43

LAN 43

Possible problems and solutions 44

System messages 45



U

unpacking 15

W

WEEE Registration Number 61

Appendix: Installation Qualification (IQ)

	Created	Reviewed	Approved
Function	Technical editor	Engineering	Head of Quality
Name	Anna Erben	Paul Pietsch	Kate Monks
Date	23/08/2022	29/08/2022	30/08/2022
Signature	 Digital unterschrieben von Anna Erben Datum: 2022.08.23 14:09:27 +02'00'		

0. Customer approval

Prior to installation at the customer site, the customer has reviewed the OQ document and agrees with the design and scope

Company name:

Name	Function	Reviewed & approved	Date	Signature

1. Definition of the Installation Qualification

The qualification document „Installation Qualification (IQ)“ is part of the quality management system at the company KNAUER Wissenschaftliche Geräte GmbH.

2. Scope

The customer can request the Installation Qualification. In case of a request, the technical support of KNAUER or a provider authorized by KNAUER performs this functionality test during the installation. The IQ is a standardized document and includes the following:

- Confirmation of flawless condition at delivery
- Check if the delivery is complete
- Certification on the functionality of the device

3. Instructions

All deviations from the specifications that occurred during installation have to be recorded in this document.

In addition, all measures taken to eliminate the deviations have to be noted down as comments in the list of rectifications (LOR) on page 4.

If certain items in the report are not applicable, this has to be indicated in the table as „N/A“ (not applicable). Major sections that are not used have to be crossed out (diagonal line), marked „N/A“, dated and signed.

All required documents have to be completed by the end of the installation. The document has to be reviewed and approved by an authorized person. The review and approval have to be documented with signature and date (DD/MM/YYYY).

The tests have to be carried out in a suitable environment, as described in the user instruction of the device.

4. About this document

The information in this document is subject to change without prior notice. This document may not be used, reproduced or translated without written consent of KNAUER Wissenschaftliche Geräte GmbH. Depending on the customer's quality assurance system, the signed document either has to be filed in the device folder or scanned and stored in an electronic archive.

5. Device data

Device name		Product number	
Serial number		Order number	
Firmware version			
Installation location			

6. Customer and manufacturer data

	Customer	Manufacturer
Company		KNAUER Wissenschaftliche Geräte GmbH
Customer number		-
Contact person/agent		
Address		Hegauer Weg 38
Postal Code/City		14163 Berlin
Phone		+49 30 80 97 27 111
E-Mail		support@knauer.net

7. Installation Qualification Tests

Test	Description	Specification	Passed	Failed	N/A	Comment/LOR No.
1	Identify the device.	The name on the device matches the name on the delivery order.				
2	Check the device for transport damage.	No transport damage is observed.				
3	Check the scope of delivery.	The scope of delivery matches the packing list and/or the delivery order.				
4	Check that the technical documentation provided is correct and complete (material documentation of wetted parts, calibration certificates etc.)	The documentation is correct and complete.				
5	Check that all equipment is properly and correctly labeled according to the delivery order and/or the labeling specifications document, if applicable.	The equipment is labeled correctly.				
6	Connect all loose parts (e.g. capillaries, tubings, measuring head) according to the user instructions.	The device is fully assembled and ready to use.				
7	Ensure that the installation site is suitable according to the user instructions.	The installation site matches the specifications in the user instructions.				
8	Connect the device to the power supply and switch it on.	The device starts (operating noise). The power LED or the display lights up.				

8. List of rectifications (LOR)

LOR No.	Test No.	Type of deviation*	Description of the deviation	Action plan	Persons responsible	Due date	Date/signature

*Type of deviation:

A = acceptable (e.g. not a GMP-critical deviation)

N = not acceptable

Continuation of qualification activities into the next qualification phase is only possible when deviation is rectified.

T = temporarily acceptable

a) Release and use of the system is possible, even when the deviation is not rectified.

b) A continuation of qualification activities into the next qualification phase is possible, even when the deviation is not rectified

9. List of changes to the document

Revision no.	Description of change	Additional information	Date/signature

10. Certificate and approval

A KNAUER employee or an employee authorized by KNAUER has checked the device and performed all tests described in the IQ.

The IQ form has to be signed by an authorized person. The scope of the IQ meets the customer’s requirements.

The results of the IQ, any changes made as well as the IQ process have been documented in this form in writing. The users listed below were instructed and are familiar with how to operate the device. Both parties confirm that the IQ has been performed to the customer’s satisfaction by signing it.

10.1 Customer approval

Name	Function	Date	Signature

10.2 KNAUER agent approval

Name	Function	Date	Signature

11. Comments / recommendations

Appendix: List of supporting documents

No.	Test no.	Description

Science with Passion



Latest KNAUER instructions online:
www.knauer.net/library

KNAUER
Wissenschaftliche Geräte GmbH
Hegauer Weg 38
14163 Berlin

Phone: +49 30 809727-0
Fax: +49 30 8015010
E-Mail: info@knauer.net
Internet: www.knauer.net